

# PRO850

## Wireless Intercom



### Operating Instructions

Base Station Version A.2.0x



**HM ELECTRONICS, INC.**  
14110 Stowe Drive, Poway, CA 92064 USA

®

# Table of Contents

<b>SECTION 1. INTRODUCTION .....</b>	<b>1</b>
EQUIPMENT FEATURES .....	2
Base Station Front Panel Features .....	2
Base Station Rear Panel Features .....	2
Beltpac Top Panel Features .....	3
Beltpac Bottom Panel Features .....	3
BLOCK DIAGRAMS .....	4
Base Station .....	4
Beltpac .....	4
EQUIPMENT SPECIFICATIONS .....	5
Base Station .....	5
Beltpac .....	6
Factory Defined Frequencies .....	7
Frequency Plan .....	8
<b>SECTION 2. EQUIPMENT SETUP.....</b>	<b>9</b>
BASE STATION SETUP.....	9
<b>SECTION 3. PRO850 OPERATION.....</b>	<b>11</b>
BASE STATION OPERATION .....	11
Uses of Front Panel Controls, Indicators and Connectors .....	11
Display Screen Navigation .....	12
Display Screen Functions and System Settings .....	13
Status Displays .....	13
Monitor Displays .....	14
Base Configuration Settings .....	15
Base Configuration Settings .....	15
Beltpac Configuration Settings.....	20
Saving and Loading Configurations .....	23
Advanced Configuration Settings.....	24
Information Displays .....	28
Diagnostic Tests .....	29
ADVANCED CONFIGURATION .....	30
Auxiliary Input and Output Functions:.....	30
Single Transmitter Two-Channel Operation.....	30
IFB Transmitter Operation .....	30
Cascading Multiple Base Stations .....	31
Aux Distributed Set Up .....	31
2-Wire Distributed Set Up.....	31
Common Configuration.....	32
Alert Relay Operation.....	32
BELTPAC OPERATION.....	33
Controls and Buttons .....	33
Indicator Lights .....	34
Connectors and Adjustment.....	35
Batteries.....	36
Infrared Window .....	36
Dual-Receiver Operation .....	36
Troubleshooting.....	37
<b>SECTION 4. PRO850 SYSTEM SOFTWARE.....</b>	<b>38</b>
PC850 Installation .....	38
PC850 Operation .....	39
<b>SECTION 5. PDA850 Installation.....</b>	<b>41</b>
PDA850 Installation .....	41
PDA850 Operation .....	41
<b>END-USER LICENSE AGREEMENT FOR HME PRO850 SYSTEM SOFTWARE .....</b>	<b>42</b>
<b>LIMITED WARRANTY .....</b>	<b>46</b>

## FCC LICENSING

The HME PRO850 is Type Accepted under Part 74 of the United States Federal Communications Commission (FCC) Code of Federal Regulations governing general purpose applications. The system requires an FCC station license if operated within the United States or its possessions. Licensing of this equipment is the User's responsibility. Licensability depends on the User's classification, equipment application and frequency selected. The user should contact the appropriate telecommunications authority for any desired clarification.

**CAUTION:** Changes or modifications made by the user could void the user's authority to operate PRO850 equipment.

## MANDATORY SAFETY INSTRUCTIONS TO INSTALLERS AND USERS

Use only manufacturer or dealer supplied antennas.

**Base Station Antenna minimum safe distance:** 9.54 inches (24.24 cm) at 100% duty cycle.

**Base Station Antenna gain:** zero dBi referenced to a monopole.

The Federal Communications Commission has adopted a safety standard for human exposure to RF (Radio Frequency) energy, which is below the OSHA (Occupational Safety and Health Act) limits.

**Antenna mounting:** The antenna supplied by the manufacturer or radio dealer must not be mounted at a location such that during radio transmission, any person or persons can come closer than the above indicated minimum safe distance to the antenna, i.e. 9.54 inches (24.24 cm) at 100% duty cycle.

To comply with current FCC RF exposure limits, the antenna must be installed at or exceeding the minimum safe distance shown above, and in accordance with the requirements of the antenna manufacturer or supplier.

**Antenna substitution:** Do not substitute any antenna for the one supplied or recommended by the manufacturer or radio dealer. You may be exposing person or persons to excess radio frequency radiation. You may contact your radio dealer or the manufacturer for further instructions.

**WARNING:** Maintain a separation distance from the base station transmit antenna to a person(s) of at least 9.54 inches (24.24 cm) at 100% duty cycle.

You, as the qualified end-user of this radio device must control the exposure conditions of bystanders to ensure the minimum separation distance (above) is maintained between the antenna and nearby persons for satisfying RF exposure compliance. The operation of this transmitter must satisfy the requirements of Occupational/Controlled Exposure Environment, for work-related use. Transmit only when person(s) are at least the minimum distance from the properly installed, externally mounted antenna.

Hereby, HM Electronics, Inc. declares that the PRO850 is in compliance with the essential requirements and other relevant provisions of EMC Directive 89/336/EEC.



Illustrations in this publication are approximate representations of the actual equipment, and may not be exactly as the equipment appears.

HM Electronics, Inc. is not responsible for equipment malfunctions due to erroneous translation of its publications from their original English version.



# EQUIPMENT FEATURES

## Base Station Front Panel Features

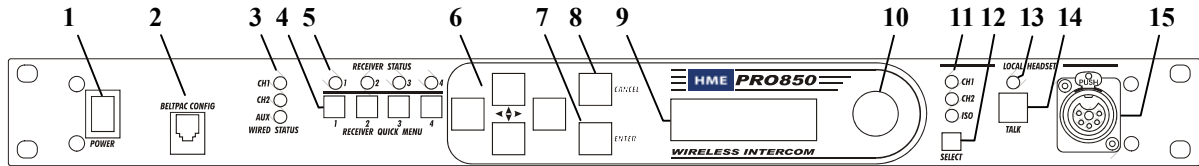

- |   |   |
|---|---|
| <ol style="list-style-type: none"> <li>1. POWER switch</li> <li>2. BELTPAC CONFIGuration connector (RJ10 telephone handset cable connector)</li> <li>3. WIRED STATUS lights<br/>CH1 = Channel 1 intercom status<br/>CH2 = Channel 2 intercom status<br/>AUX = ISO+ mode</li> <li>4. RECEIVER QUICK MENU buttons</li> <li>5. RECEIVER STATUS lights</li> <li>6. Arrow buttons (move cursor around on menu)</li> <li>7. ENTER button (selects function or setting)</li> </ol> | <ol style="list-style-type: none"> <li>8. CANCEL button (backs out of menus or cancels operation)</li> <li>9. Display screen</li> <li>10. Multi-function knob (headset volume control; adjustment for specific menu selections)</li> <li>11. Local headset function lights</li> <li>12. Local headset function select switch</li> <li>13. Local headset TALK indicator light</li> <li>14. Local headset TALK switch</li> <li>15. Local headset connector</li> </ol> |
|---|---|

## Base Station Rear Panel Features

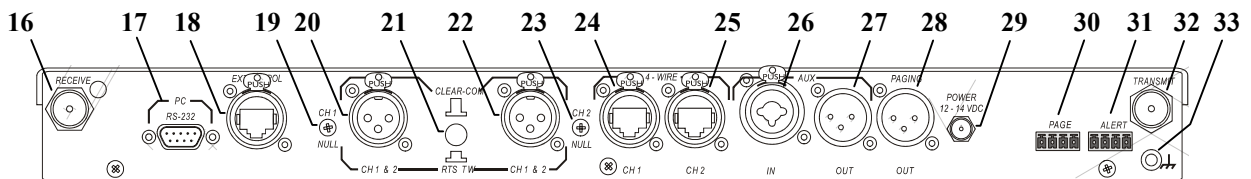

- |  |  |
|--|--|
| <ol style="list-style-type: none"> <li>16. Receiver antenna connector</li> <li>17. 9-pin RS-232 computer connector</li> <li>18. RS-422 interface (for connecting two or more bases together)</li> <li>19. Channel 1 null adjustment</li> <li>20. Channel 1 2-wire intercom interface connector</li> <li>21. Clear-Com/RTS select button</li> <li>22. Channel 2 2-wire intercom interface connector</li> <li>23. Channel 2 null adjustment</li> <li>24. Channel 1 RJ45 4-wire intercom interface connector</li> </ol> | <ol style="list-style-type: none"> <li>25. Channel 2 RJ45 4-wire intercom interface connector</li> <li>26. Auxiliary input connector (accepts XLR plug or standard phone plug)</li> <li>27. Auxiliary output connector</li> <li>28. Paging output connector</li> <li>29. 12-14VDC power jack</li> <li>30. Page relay connector</li> <li>31. Alert relay connector</li> <li>32. Transmitter antenna connector</li> <li>33. Grounding screw</li> </ol> |
|--|--|

---

## Beltpac Top Panel Features

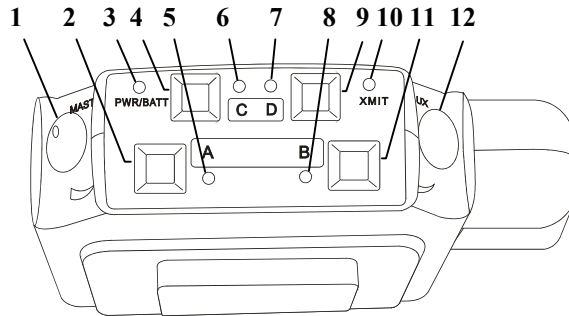

- |   |   |
|---|---|
| 1. Master power/volume control            | 7. “D” function light                         |
| 2. “A” button                             | 8. “B” light – indicates Channel 2 active     |
| 3. Power and battery condition indicator  | 9. “D” button                                 |
| 4. “C” button                             | 10. Transmit light – indicates transmitter on |
| 5. “A” light – indicates Channel 1 active | 11. “B” button                                |
| 6. “C” function light                     | 12. Auxiliary volume control                  |

---

## Beltpac Bottom Panel Features

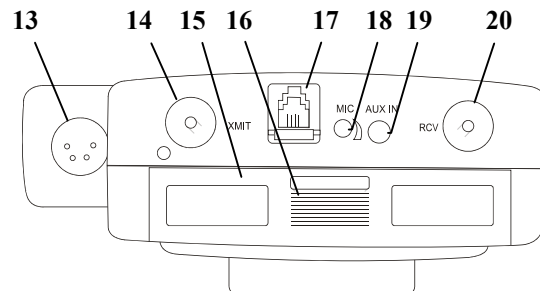

- |                                   |                                    |
|-----------------------------------|------------------------------------|
| 13. Headset connector             | 17. Remote configuration connector |
| 14. Transmitter antenna connector | 18. Microphone gain adjustment     |
| 15. Battery compartment cover     | 19. Auxiliary input connector      |
| 16. Battery cover thumb grip      | 20. Receiver antenna connector     |

# BLOCK DIAGRAMS

## Base Station

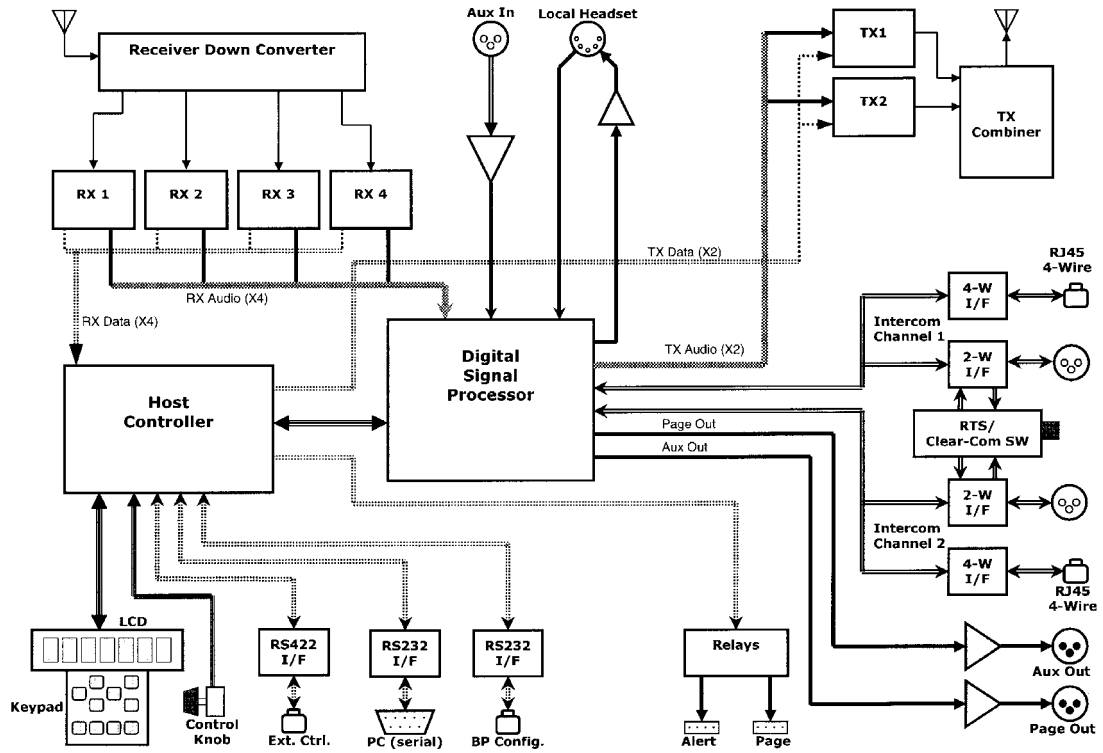

## Beltpac

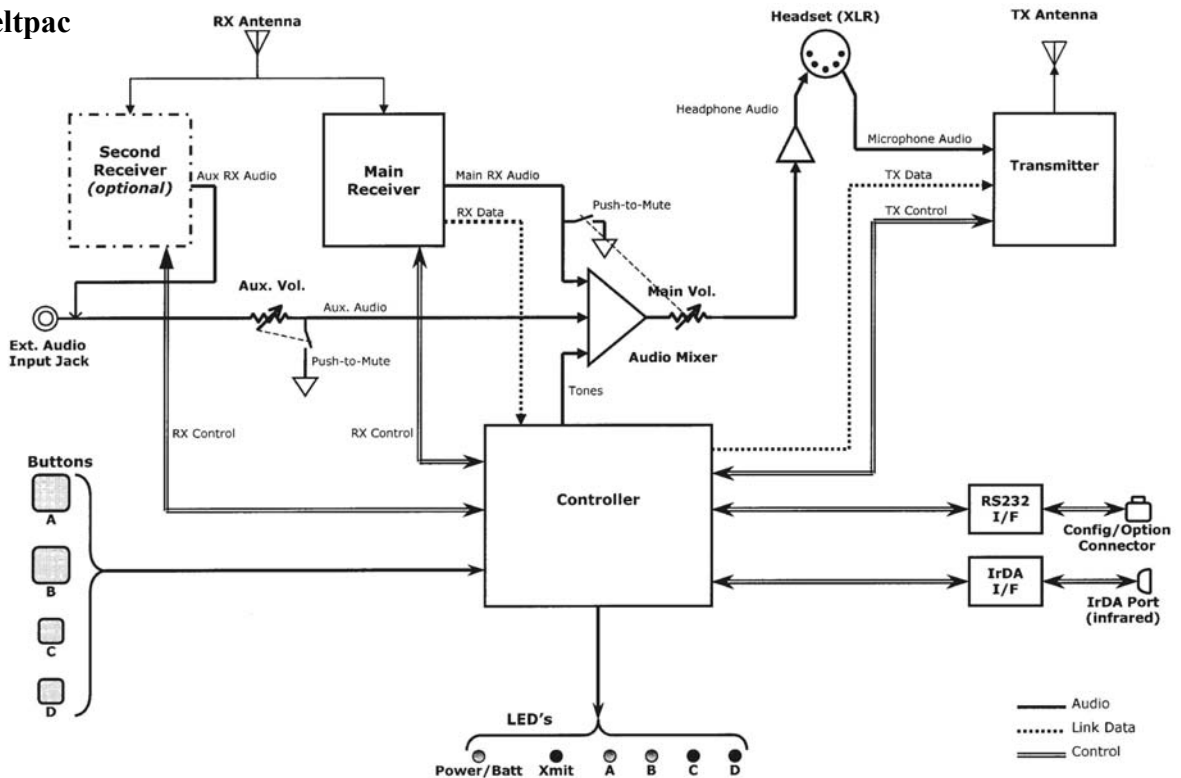

# ***EQUIPMENT SPECIFICATIONS***

---

## **Base Station**

### **GENERAL —**

Frequency Range:	470-608 MHz, 614-740 MHz in 18 MHz TX and RX bands	
Frequency Response:	50 Hz to 10 kHz	
Power Requirements:	100-240VAC, 50-60Hz or 12-14VDC	
Temperature Range:	32-122°F (0-50°C)	
Size:	19" x 1.72" x 11.5" (1-RU) (48.26 x 4.37 x 29.21 cm)	
Weight:	<11 lbs. (4.99 kg maximum)	
# of Receivers:	1 to 4, configurable	
# of Transmitters:	0 to 2, configurable	
4-Wire I/O:	RJ45, 600Ω balanced, level adjustable, simultaneous operation with 2-wire	
2-Wire I/O:	XLR-3F, externally-switchable RTS® or Clear-Com® mode, 200Ω, level adjustable, null adjustable	
Auxiliary Input:	XLR-3F/¼" (6.35 mm) combo jack, 600Ω balanced, level adjustable	
Auxiliary Output:	XLR-3M, 600Ω balanced, level adjustable	
Paging Output:	XLR-3M, 600Ω balanced, level adjustable	
Page & Alert Relay:	2 four-pin Molex, 60W switching capacity (2A @ 30VDC)	
Belpac Interface:	RJ10, RS-232	
PC Interface:	DB9, RS-232, 38400 baud	
External Control Interface:	RJ45, RS-422	
Headset Connector:	<u>XLR-4M</u>	<u>Optional field-installable XLR-5F</u>
	pin 1 = mic-lo pin 2 = mic-hi pin 3 = ear-lo pin 4 = ear-hi	pin 1 = mic-lo pin 2 = mic-hi pin 3 = common pin 4 = ear-left pin 5 = ear-right
Mic Input:	Auto-detect, low impedance dynamic or electret microphone	
Headset Output:	Stereo – 160mW per side Mono – >200mW into 50Ω	
Front Panel Controls:	Power Switch Up, Down, Left, Right, Enter & Cancel Menu Buttons Receiver Quick-Menu Buttons Rotary knob for adjustments Headset channel select & PTT	
Front Panel Indicators:	Graphic LCD, 4 Receiver Status LEDs, 3 Intercom Status LEDs, 3 Headset channel select LEDs, Headset PTT LED	
Rear Panel Controls:	2-wire channel line null RTS®/Clear-Com® mode switch	

### **TRANSMITTER —**

Type:	720 synthesized, 25 kHz channel steps
Transmit Power:	240, 100, 10 or 1 mW
Modulation Type:	FM
Deviation:	50 kHz
Occupied Bandwidth:	190 kHz maximum
Frequency Stability:	10 ppm
Harmonics/Spurious:	Exceeds FCC specifications
Antenna Type:	¼-wave whip (supplied) or external (BNC connector)

**RECEIVER —**

Type:	720 synthesized, 25 kHz channel steps
RF Sensitivity:	<1 $\mu$ V for 20dB SINAD
Squelch:	Adjustable
Image Rejection:	60dB
Squelch:	Data channel coded plus carrier signal level
Squelch Quieting:	90dB
Frequency Stability:	10 ppm
Distortion:	<1% at maximum deviation
Antenna Type:	¼-wave whip (supplied) or external (BNC connector)

**Beltpac****GENERAL —**

Frequency Range:	470-608 MHz, 614-740 MHz in 18 MHz TX and RX bands
Antenna Type:	Flexible ¼-wave, field-replaceable
Frequency Response:	50 Hz to 10 kHz
Battery Requirements:	6 “AA” Alkaline Cells (optional NiMH)
Battery Life:	PTE – Up to 9 hours (alkaline), PTT – Up to 15 hours (alkaline)
Temperature Range:	32-122°F (0-50°C)
Weight:	16 oz (.454 kg) with batteries
Base Interface:	RJ10, RS-232
PDA Interface:	IrDA
Auxiliary Input:	Connector: 1/8” (3.18 mm) miniature phone jack Impedance: 10k $\Omega$ Receive Level: 100mV minimum Overrides optional 2nd receiver if installed
Headset Connector:	XLR-4M, optional field-installable XLR-5F
Mic Input:	Auto-detect, low impedance dynamic or electret microphone
Headset Output:	200mW @ 1% THD into 50 $\Omega$ , capable of driving 8-400 $\Omega$
Controls:	Main Volume Control with power switch and push-to-mute, 2nd RCVR/Ext. Volume Control with push-to-mute, 4 mode/function switches Microphone gain adjustment
Indicators:	Power/low battery LED, Transmit LED, 2 channel LEDs, 2 function LEDs

**TRANSMITTER —**

Type:	Synthesized, 720 25 kHz channel steps
Transmit Power:	100, 50, 10 or 1 mW configurable for fixed output or automatic power control
Transmission Modes:	Push-to-talk (PTT), push-to-talk-shared (PTS), or push-to-enable (PTE) May be configured for momentary or latch mode
Modulation Type:	FM
Deviation:	50 kHz
Occupied Bandwidth:	190 kHz maximum
Frequency Stability:	10 ppm
Harmonics/Spurious:	Exceeds FCC specifications

**RECEIVER —**

Type:	Synthesized, 720 25 kHz channel steps
RF Sensitivity:	<1 $\mu$ V for 20dB SINAD
Image Rejection:	60dB
Squelch:	Adjustable carrier signal level
Squelch Quieting:	80dB
Frequency Stability:	10 ppm
Distortion:	<1% at maximum deviation



## Frequency Plan

PRO850 frequency bands (MHz) along with US TV channel assignments.

Base and Belt-Pac use corresponding band pairs: 0 & 8, 1 & 9, 2 & A, 3 & B, 4 & C, 5 & D, 6 & E

Antenna marking colors are shown in parenthesis.

### Base Transmit Bands

CH 14	CH 15	CH 16	CH 17	CH 18	CH 19	CH 20	CH 21	CH 22	CH 23	CH 24	CH 25	CH 26	CH 27	CH 28	CH 29	CH 30	CH 31	CH 32	CH 33	CH 34		
BAND 0			BAND 1			BAND 2 (none – black)			BAND 3			BAND 4 (red)			BAND 5			BAND 6				
470 MHz			488			506			524			542			560			578			596	

### Belt-Pac Transmit Bands

CH 38	CH 39	CH 40	CH 41	CH 42	CH 43	CH 44	CH 45	CH 46	CH 47	CH 48	CH 49	CH 50	CH 51	CH 52	CH 53	CH 54	CH 55	CH 56	CH 57	CH 58		
BAND 8			BAND 9			BAND A (white)			BAND B			BAND C (yellow)			BAND D			BAND E				
614 MHz			632			650			668			686			704			722			740	

**NOTE:** Band pairs 2A and 4C are current production.

## SECTION 2. EQUIPMENT SETUP

### ***BASE STATION SETUP***

Connect equipment and make adjustments described below to the rear panel of the base station where indicated on this illustration.

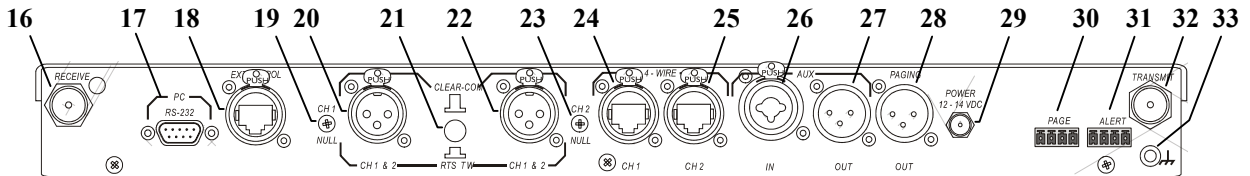

**Base station rear panel**

- 16. RECEIVE Antenna Connector** — Connect the receiver antenna to this BNC connector. The color band (if present) around the antenna should match the color dot (if present) near the connector on the base.
- 17. RS-232 Interface Connector** — To interface the PRO850 with a PC using a computer interconnect cable with a 9-pin RS-232 serial interface connector, connect the cable from this connector to the PC.
- 18. Multiple Base Station Interface Connector** — Use this RS-422 serial interface to connect Master and Slave base stations together.

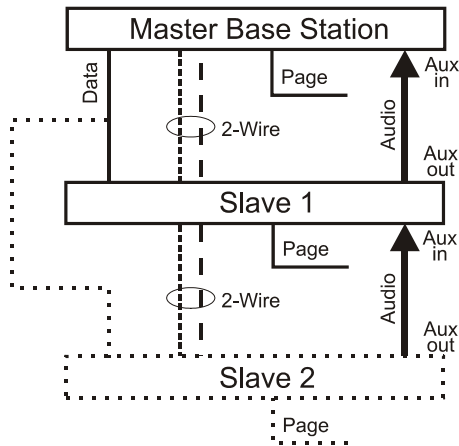

**Master-Slave Base Station Configuration**

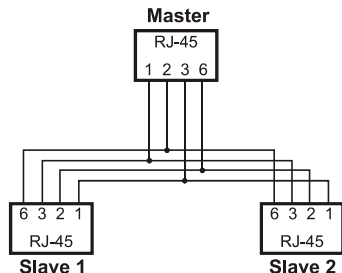

**Data Cable Configuration for More Than One Slave Base Station**

In the **2-Wire ISO+** mode, the headset connector on the front panel of the base station is disabled from normal headset functions and becomes available for connection to devices other than a headset.

In the **2-Wire** mode;

- If you have an RTS system, only one 2-wire cable is needed for connecting bases. The switch on the back panel of the base station (#21 above) must be set for **RTS TW**. One cable carries both CH1 and CH2.
- If you have a Clear-Com system, two cables are needed for connecting base stations. The switch on the back panel of the base station (#21 above) must be set for **CLEAR-COM**.

In all multibase configurations, connect the Aux Out from Slave 1 to the Aux In of the Master Base Station and connect the Aux Out from Slave 2 (if present) to the Aux In of Slave 1.

**NOTE:** When only one Slave will be cascaded with a Master, a standard Ethernet crossover cable can be used for the data connection. This is the type of cable used to connect two computers without a hub or router. It is available in stores.

**19. Channel 1 Line Nulling Control** — Use this adjustment to null the Channel 1, 2-wire connection when attached to other cabled intercom devices. This control is active even if the 4-wire only mode is selected.

**20. Channel 1 2-Wire Intercom Connector** — Provides 3-pin female XLR connector for interfacing other cabled intercom devices to Channel 1 on the PRO850.

**NOTE:** PRO850 does not provide or require 2-wire line power.

RTS® Mode:	Pin 1 = Common	Clear-Com® Mode:	Pin 1 = Common
	Pin 2 = Channel 1		Pin 2 = N/C
	Pin 3 = Channel 2		Pin 3 = Channel 1

**21. Clear-Com®/RTS® Select Button** — In position = RTS® Mode      Out position = Clear-Com® Mode

**22. Channel 2 2-Wire Intercom Connector** — Provides 3-pin female XLR connector for interfacing other cabled intercom devices to Channel 2 on the PRO850.

**NOTE:** PRO850 does not provide or require 2-wire line power.

RTS® Mode:	Pin 1 = Common	Clear-Com® Mode:	Pin 1 = Common
	Pin 2 = Channel 1		Pin 2 = N/C
	Pin 3 = Channel 2		Pin 3 = Channel 2

**23. Channel 2 Line Nulling Adjustment** — Use this adjustment to null the Channel 2, 2-wire connection when attached to other cabled intercom devices. This control is active even if the 4-wire only mode is selected.

**24. Channel 1 RJ45 4-wire Intercom Interface Connector** — Use this RJ45 connector for 600Ω balanced interface of PRO850 Channel 1 with other cabled intercoms. Pin designations are as follows.

Pins 1, 2, 7 & 8 have no connection  
 Pin 3 = Intercom Out +  
 Pin 4 = Intercom In +  
 Pin 5 = Intercom In –  
 Pin 6 = Intercom Out –

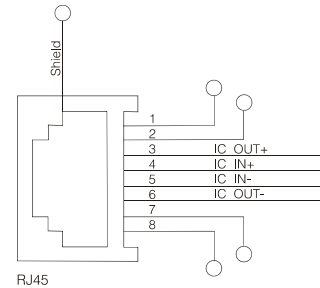

**25. Channel 2 RJ45 4-wire Intercom Interface Connector** — Same as #10, but for Channel 2.

**26. Auxiliary Input Connector** — Use this 3-pin female XLR/standard-phone-jack connector for balanced +20dBV maximum auxiliary audio input.

Pin 1 = Ground = Sleeve  
 Pin 2 = Audio + = Tip  
 Pin 3 = Audio – = Ring

**27. Auxiliary Output Connector** — Use this 3-pin male XLR connector for balanced +20dBV maximum auxiliary audio output.

Pin 1 = Ground  
 Pin 2 = Audio +  
 Pin 3 = Audio –

**28. Paging Output Connector** — Use this 3-pin male XLR connector for balanced +20dBV maximum paging audio output.

Pin 1 = Ground  
 Pin 2 = Audio +  
 Pin 3 = Audio –

**29. 12-14VDC Power Jack** — Use this connector for DC power input.

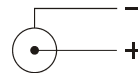

**30. Page Relay Connector** — Use this 4-pin Phoenix connector for relay closure based on Beltpac page control. Switching capacity of the relay is 60W (2A @ 30VDC). Pin designations are as follows.

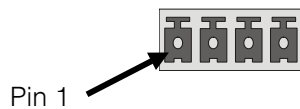

Pin 1 = Common  
 Pin 2 = Normally Closed  
 Pin 3 = Normally Open  
 Pin 4 = Ground

**31. Alert Relay Connector** — Use this 4-pin Phoenix connector for relay closure based on alert conditions. Switching capacity of the relay is 60W (2A @ 30VDC). Pin designations are the same as for #16 above.

**32. TRANSMIT Antenna Connector** — Connect the transmitter antenna to this BNC connector. The color band (if present) around the antenna should match the color dot (if present) near the connector on the base.

**33. Grounding Screw** — Tie this connector to earth ground if the chassis is not otherwise grounded.

## SECTION 3. PRO850 OPERATION

### BASE STATION OPERATION

#### Uses of Front Panel Controls, Indicators and Connectors

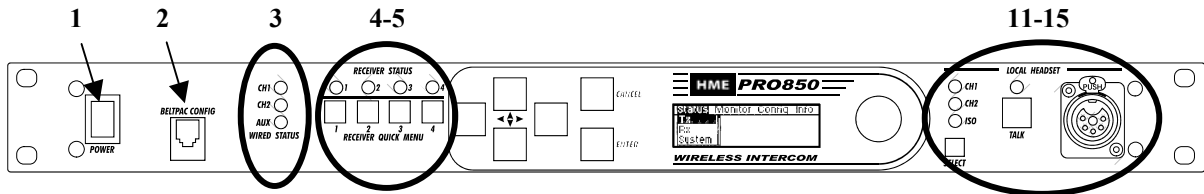

#### 1. Power Switch

Press the upper part of the switch to turn the power on. A red light on the switch will be lit when the base station power is on. Press the lower part of the switch to turn the power off. The red light will go off.

#### 2. Beltpac Configuration Connector

After Beltpac configuration settings have been made in the base station, plug one end of the enclosed RJ10 interconnect cable into this connector, and plug the other end into the RMT receptacle on the bottom of a Beltpac to upload the settings into the Beltpac. Repeat this to upload settings for each Beltpac to be used.

**CAUTION:** Be sure not to turn the Beltpac power off and on again while it is connected to the base station. If this does happen, unplug the cable and cycle the Beltpac power again.

#### 3. Wired Status Indicator Lights

**CH1 and CH2 lights:**

If a 4-wire intercom channel is enabled, the respective CH1/CH2 light will blink when the PRO850 is sending audio on that intercom line.

If a 2-wire interface channel is enabled, the respective CH1/CH2 light will be on steady when the user is not talking. When the user is talking, the light will be on steady and blinking off.

**AUX light:**

The auxiliary light indicates use of the ISO+ mode. When ISO+ is on, the AUX light will be on steady. When someone is talking on the ISO channel, the light will be on steady and blinking off.

#### 4-5. Receiver Status Indicators and Buttons

**RECEIVER STATUS lights 1 – 4:**

**Steady red** if the respective receiver squelch is turned down, or if it is receiving a signal (squelch is open).

**Blinking amber** when the respective receiver is receiving status update from a Beltpac.

**Steady green** when the Beltpac user is talking through the receiver.

**Blinking red or green** if the Beltpac being received has a low battery condition.

**RECEIVER QUICK MENU buttons 1 – 4:**

When pressed, squelch and audio controls for the respective receiver are provided immediately on the display screen.

#### 11-15. Local Headset Connector and Controls

Plug your local headset connector into the receptacle at the right end of the PRO850 front panel.

Use the SELECT button to choose communication channels CH1, CH2, CH1 and CH2 together, or ISO.

The respective indicator light above the button will remain lit for the selection you make.

Press and release the TALK button quickly to “latch on” for open communication. Press and release the button again quickly to “latch off.”

Press and hold the TALK button for more than one second for momentary communication. In this mode, the selected channel will remain open only as long as you are pressing the TALK button.

## Display Screen Navigation

6-10

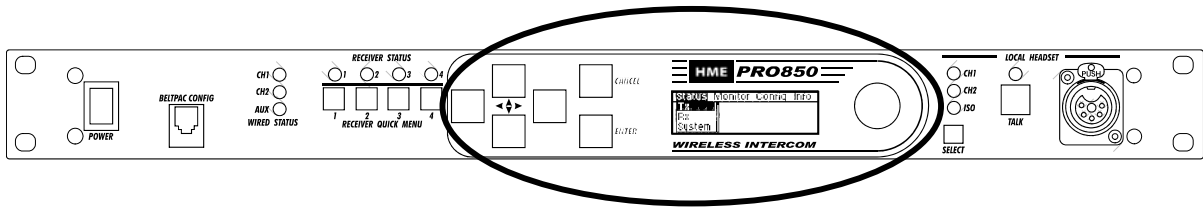

6-10. To navigate through PRO850 screen displays, use the ◀▶▲▼, *ENTER* and *CANCEL* buttons and the control knob adjacent to the screen as follows.

- ◀▶ Use the left and right arrow buttons to move through horizontal selections on the bar at the top of the main menu, and to move to the left and right on advanced screens.

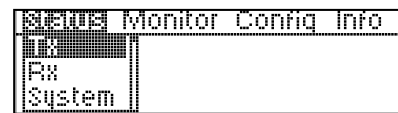

Main Menu

- ▲▼ Use the up and down arrow buttons to move through vertical selections on the main menu, such as **Tx**, **Rx** and **System**, and to move up and down on the screen.



The bar next to vertical selections has an indicator in it that moves up or down as you use the up and down arrow buttons to move through selections. The indicator will move up and down the bar in increments, from the top of the bar for the first selection to the bottom of the bar for the last selection.

**NOTE:** Holding an arrow button continuously will allow you to move rapidly through selections.

- ▲▼ When a **cursor** appears on the screen, use any of the four arrow buttons to move it around to desired selectable items, or to change the content of a box adjacent to the cursor.

Currently selected items are highlighted.

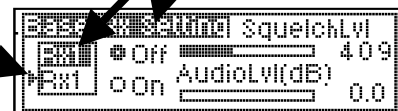

Use the *ENTER* button to make a selection indicated by a cursor or highlighted button (e.g. Off/On), or to advance to the next screen from a highlighted selection.

Use the *CANCEL* button to move back to a previous screen. Press *CANCEL* repeatedly to return to the main menu.

Use the **control knob** to adjust values selected with the cursor such as frequencies, squelch levels and auxiliary output mix levels.

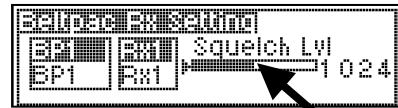

Use the **control knob together with the up and down arrow buttons** to change numbers such as frequency numbers, or words such as Beltpac user names in selected boxes. The arrow buttons move highlighted numbers left and right, while the control knob changes the numbers, letters or symbols.

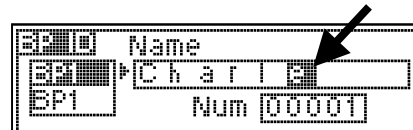

---

## Display Screen Functions and System Settings

### Status Displays

Status displays provide information indicating the status of the system, or of parts or functions of the system.

---

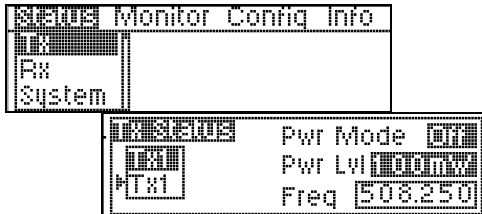

#### Transmitter Status:

Select transmitter 1 or 2, then press the **ENTER** button to obtain the status of the selected transmitter.

---

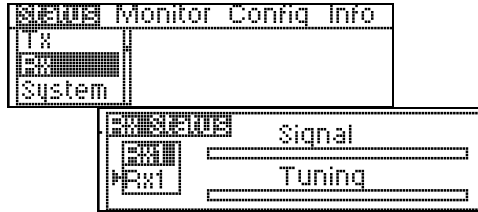

#### Receiver Status:

Select receiver 1 through 4, then press the **ENTER** button to observe signal and tuning levels at the selected receiver.

---

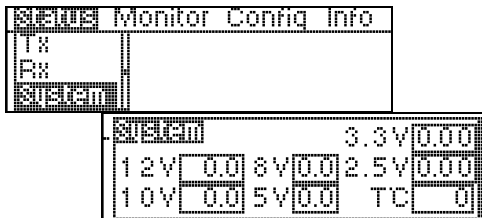

#### System Status:

Base station power supply voltages are shown. The **12V** box shows the actual input voltage supplied to the base station. The **T°C** box shows base station internal temperature in degrees Celsius.

---

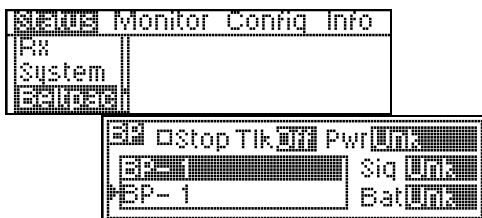

#### Beltpac Status:

Select a Beltpac by the name or number shown, then press the **ENTER** button to obtain its status.

Select **Stop Tlk** to stop a latched-on Beltpac from transmitting.

The **Pwr** box shows the current transmitter power level of the selected Beltpac.

The **Sig** box indicates how well the Beltpac is receiving transmission (Low, OK or High) from the base station.

The **Bat** box shows battery status of the selected Beltpac (OK, Low or Dead).

---

**NOTE:** In Push-To-Talk (PTT) or Push-To-Enable (PTE) modes, Beltpacs automatically update status to the base station every 3 seconds. In Push-To-Share (PTS) mode, Beltpacs only update status while they are transmitting. If no transmission is received from a Beltpac within 20 seconds, its status will be shown as Unk (unknown). Also, if a Beltpac is out of range, or its power is off, its status will be shown as Unk.

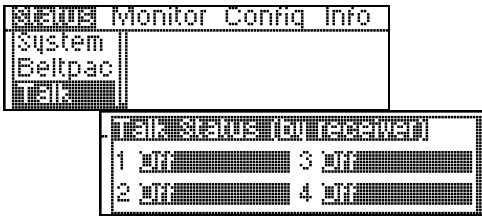

**Talk Status:**

Beltpac user identification is shown when Beltpac user is pressing Talk button.

**Monitor Displays**

Monitor displays provide input/output levels and input level adjustments for all devices connected to the base station.

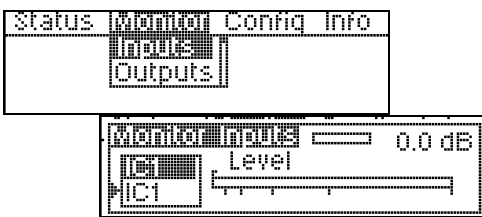

**Monitors Audio Levels at Base Station Inputs:**

Select the desired input source, then move the cursor to the bar at the top of the screen. Use the control knob to adjust the audio input level from the selected source in 1.5dB increments.

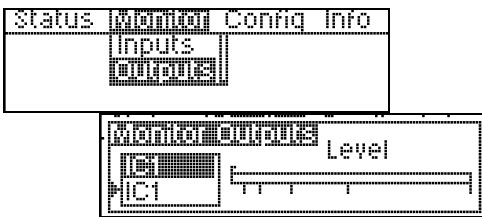

**Monitors Audio Levels at Base Station Outputs:**

Use the up/down arrow button to view the output level from the DSP of the desired output to be monitored.

## Base Configuration Settings

Configuration displays provide customized configuration settings for the base station and Beltpac. They also allow you to save your settings to a file for future access. Advanced settings are provided for output mixing, alert signals and paging capabilities. Beltpac ID name and number settings made at the main base station can be synchronized in added Slave base stations via the Configuration, Sync Bases display.

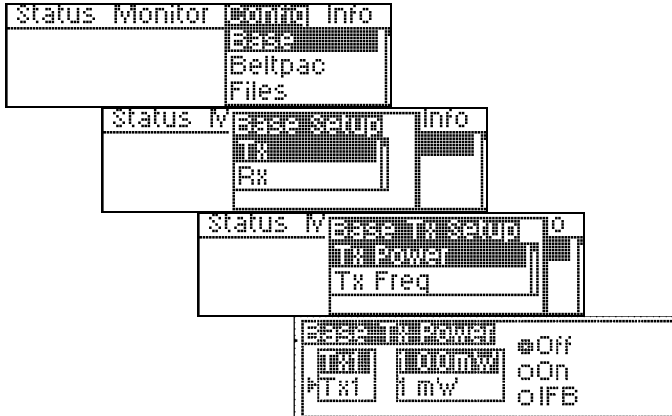

### Base Station Transmitter Power:

Select transmitter 1 or 2, then press the **ENTER** button.

At the power level box, select 1, 10, 100 or 250mW, then press the **ENTER** button. To change the Off/On status of the transmitter, select the Off or On button, then press the **ENTER** button.

To enable IFB mode (only usable with dual receiver Beltpacs), select the IFB button, then press the **ENTER** button.

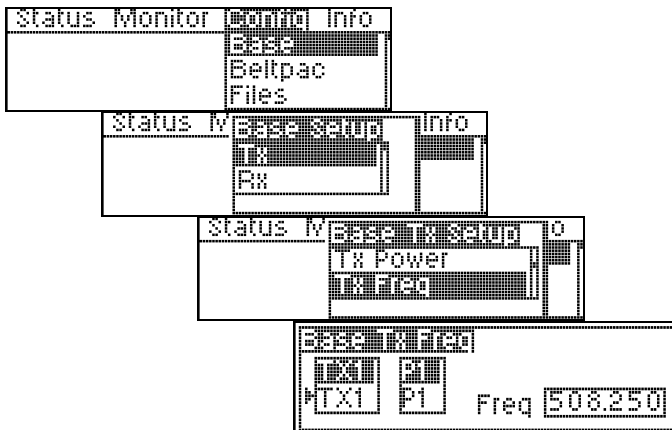

### Base Station Transmitter Frequency:

Frequencies P1 – P4, S1 – S4 and T1 – T4 are preset in the system and cannot be changed. Frequencies U1 – U5 can be set by the user.

Select transmitter TX1 or TX2, then select a frequency for that transmitter. If you select a user frequency, U1 – U5, move the cursor to the frequency box and use the up and down arrow buttons together with the control knob to select a frequency. User frequencies can be selected in 25kHz increments.

**NOTE:** Frequencies within the same group (P, S or T) are compatible with each other and free of intermodulation.

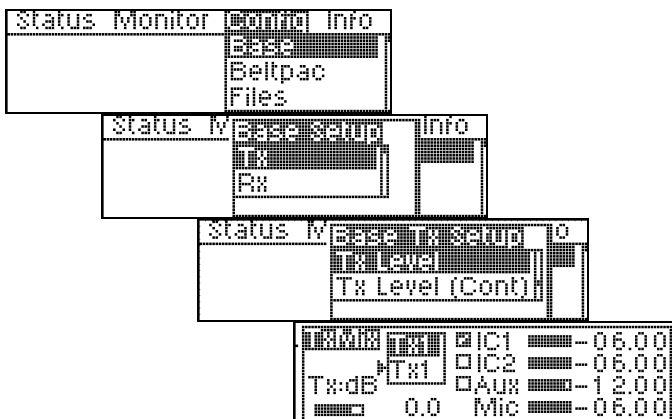

### Base Station Transmitter Output Mix Levels:

Select transmitter 1 or 2, then press the **ENTER** button.

Use the left arrow button to select the Tx box, then use the control knob to adjust the transmitter Master output level in 1.5dB increments.

Select a box next to IC1, IC2 or Aux to enable that input in the output mix. Mic is a standard input.

Place the cursor to the left of any slider bar and use the control knob to adjust each output level in increments of .25dB (fine) or 2.25dB (course).

**NOTE:** See Dial Adjustment Setting (page 20) for information on changing between fine and course.

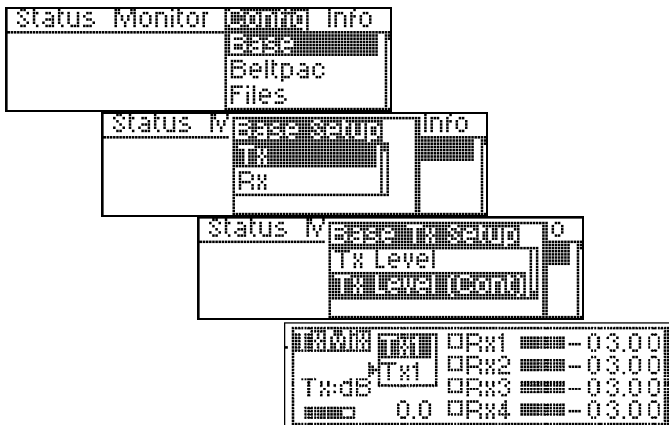

**Base Station Transmitter Mix Levels (continued):**

Select transmitter 1 or 2, then press the **ENTER** button. Use the left arrow button to select the **Tx:dB** box, then use the control knob to adjust the transmitter output level in 1.5dB increments.

Select the box to the left of RX1 through RX4, to continuously enable a particular receiver to the transmitter. **NOTE:** Leave these boxes unchecked for normal operation.

Place the cursor to the left of any slider box and use the control knob to adjust each output level in increments of .25dB (fine) or 2.25dB (coarse).

**NOTE:** See Dial Adjustment Setting (page 20) for information on changing between fine and course.

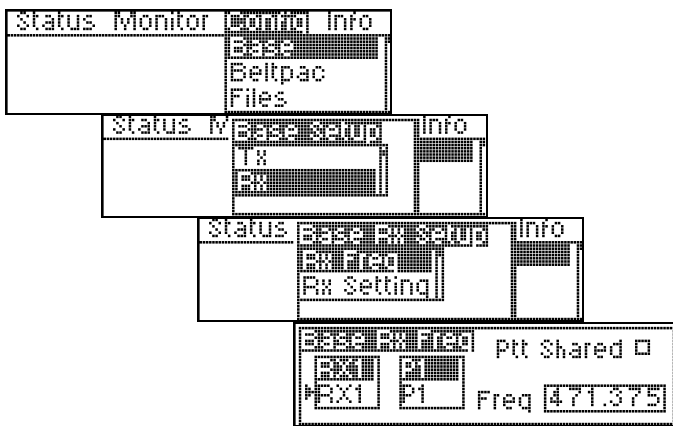

**Base Station Receiver Frequency:**

Frequencies P1 – P4, S1 – S4 and T1 – T4 are preset in the system and cannot be changed. Frequencies U1 – U5 can be set by the user.

Select receiver RX1 – RX4, then select a frequency for that receiver. If you select a user frequency, U1 – U5, move the cursor to the frequency box and use the up and down arrow buttons together with the control knob to select a frequency. User frequencies can be selected in 25kHz increments.

For multiple Beltpac to share a receiver frequency (PTS), check the **Ptt Shared** box. If you select **Ptt Shared** you must also set the Beltpac transmitters to **pts** (See page 20).

**NOTE:** Frequencies within the same group (P, S or T) are compatible with each other and free of intermodulation.

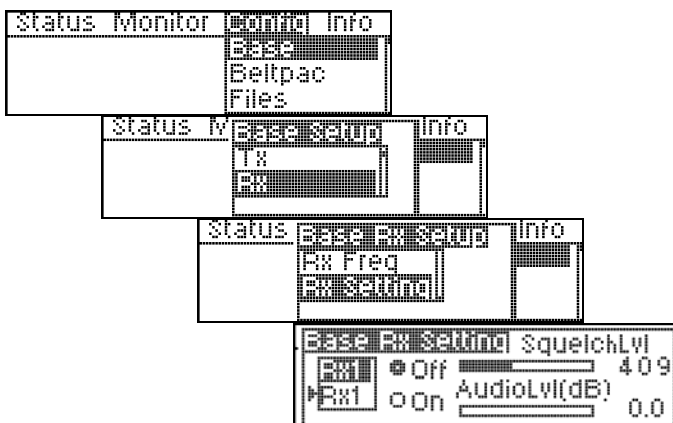

**Base Station Receiver Control:**

Select a receiver and select the **Off** or **On** button to turn it off or on. Use the up and down arrow buttons together with the control knob to adjust the squelch and audio levels.

**NOTE:** The amount of gain applied here to receiver audio level at input of DSP will also be shown on the Monitor Input display screen for that receiver.

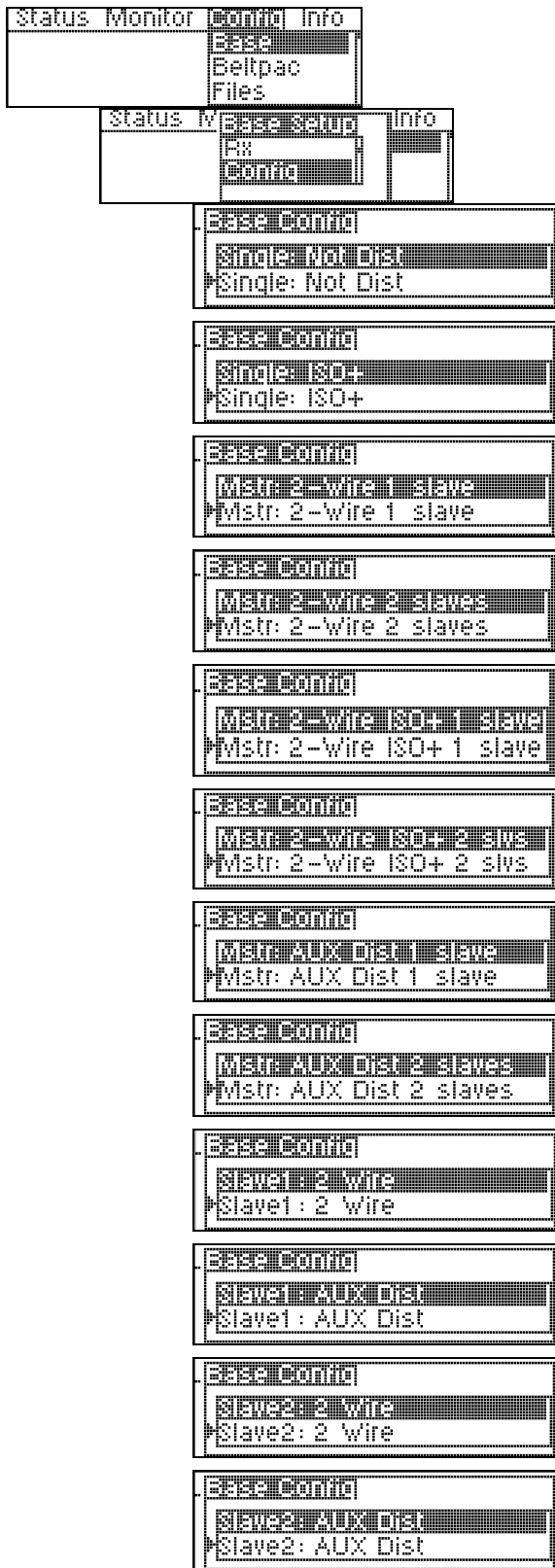

## Base Station Configuration:

### Single

Select **Single: Not Dist** for a single base station without the ISO+ feature for ISO communication only among Beltpacs.

Select **Single: ISO+** for a single base station with the ISO+ feature for ISO communication among Beltpacs and auxiliary input and output (Aux In/Out) connections.

### Master / Slaves

If Master and Slave base stations will be used, there can only be one Master base station, with one or two Slaves. Select Master, Slave 1 or Slave 2, then select the multibase wiring configuration; 2-Wire, 2-Wire ISO+ or Aux Dist.

**NOTE:** Slaves must be configured for the same type of audio distribution as the Master.

#### Master —

In the **2-Wire ISO+** mode, Beltpacs having a button configured for Talk Aux must transmit on frequencies for the Master base station for the feature to work.

#### Slaves —

In the **Aux Dist** mode, Beltpacs on Slave base stations can only talk on the same channel at once. If they try to talk on a different channel than the user already talking, they will hear a busy signal in their Beltpac headset.

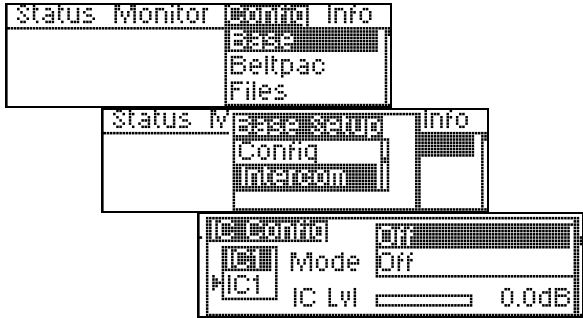

**Base Station Intercom Configuration:**

Select intercom IC1 or IC2, then use the up and down buttons to select what Mode the intercom is in; OFF, 4-Wire Only or 2-Wire/4-Wire.

Select the **IC Lvl** box, and use the control knob to adjust the input gain level.

**NOTE:** If the Mode is set to Off, the input and output of that intercom will be off. For 2-wire, set to “2-wire/4-wire.” Both will be active. If set for 4-wire, only 4-wire interface will be active. Even when “4-wire only” is selected, the line null control(s) on the rear panel must be properly adjusted to avoid excessive retransmit levels.

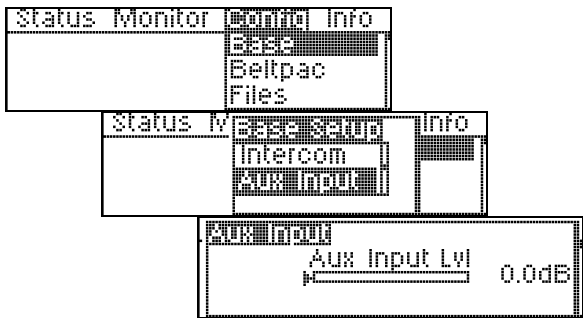

**Base Station Auxiliary Input Level:**

Use the control knob to adjust the auxiliary input level. Any change made here will be reflected in the Monitor Input display for Aux Input.

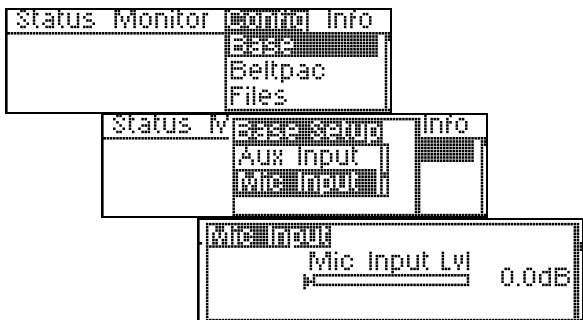

**Base Station Microphone Input Level:**

Use the control knob to adjust the front-panel headset microphone input level. Any change made here will be reflected in the Monitor Input display for the Mic Input.

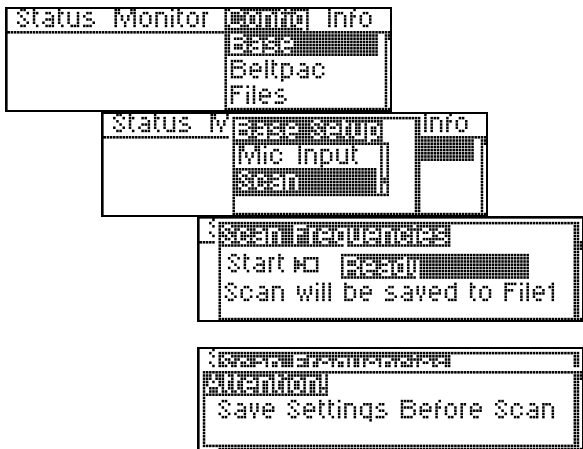

**NOTE:** In a Master/Slave configuration, always perform frequency scans at the Master base. The Master will automatically save its settings in File 1. However, the Slave(s) will not. Slave settings must be saved manually at each Slave, or with PC850.

**Frequency Scan:**

Connect a Beltpac to the BELTPAC CONFIG connector on the front panel of the base station to enable scanning of base transmit frequencies.

In this operation, the Beltpac and base station receivers are scanned to find the cleanest group of frequencies for the base station to transmit on, and they are assigned to TX1 and TX2 in the base station. Also, based on the number of receivers in the system (up to 12), it determines the best group of frequencies for the base station(s) to receive on. Those frequencies are distributed (first-come, first-served) to the Beltpacs (assuming 16 Beltpacs will be used) as Beltpac transmit frequencies. Beltpac receiver frequencies are always the same as the base station TX1 and TX2 frequencies.

Beltpac frequency settings will not be operational until they are uploaded to the Beltpacs, which should be done after completion of Beltpac configuration settings.

These settings will automatically be saved to **File 1** as active settings for the base station until the frequencies are scanned again. They can also be saved to another file name for future use.

To begin frequency scanning, press the **ENTER** button. A warning message will be displayed. Press **CANCEL** to clear the message. Press **ENTER** again to start the scan.

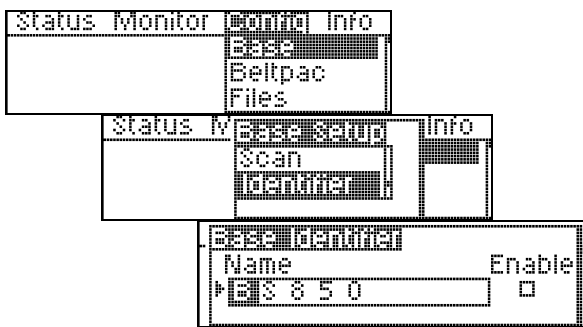

**Base Station Identifier:**

Use the arrow buttons and control knob to assign an identifying name or number of up to nine characters to the base station.

To enable the display of the name as a screen saver when other operations are not being performed, check the **Enable** box. The base name will be displayed a few minutes after the last button has been pressed. Once the screen saver is active, press **Cancel** to clear it.

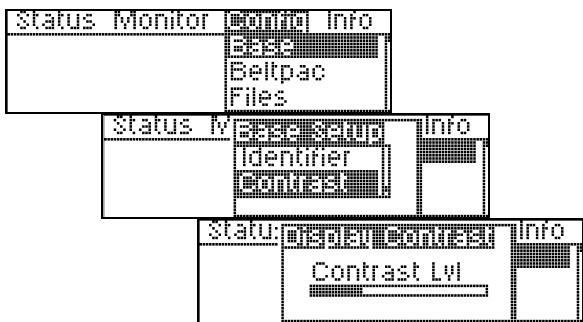

**Base Station Display Contrast Level:**

Use the control knob to adjust the base station display screen contrast level.

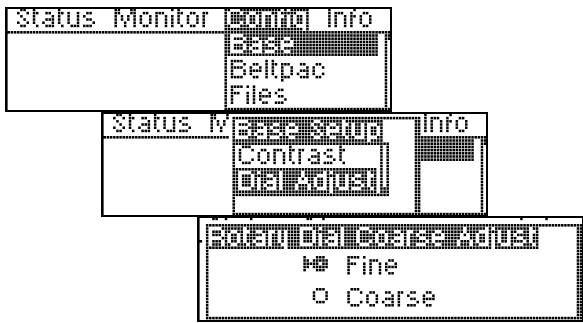

**Base Station Dial Adjustment Setting:**

Select Fine or Coarse for the control knob, for mix level dial adjustments. In the Fine mode, mix level adjustments made by the control knob occur in 0.25dB increments. In the Coarse mode, they occur in 2.25dB increments.

**Belpac Configuration Settings**

Belpac configuration settings are stored in the base station, but do not become effective until they are uploaded into individual Belpacs. In a Master/Slave configuration, all Belpac settings changes must be made at the Master. Uploading is also done at the Master. Be sure to SYNC bases after making settings changes at the Master.

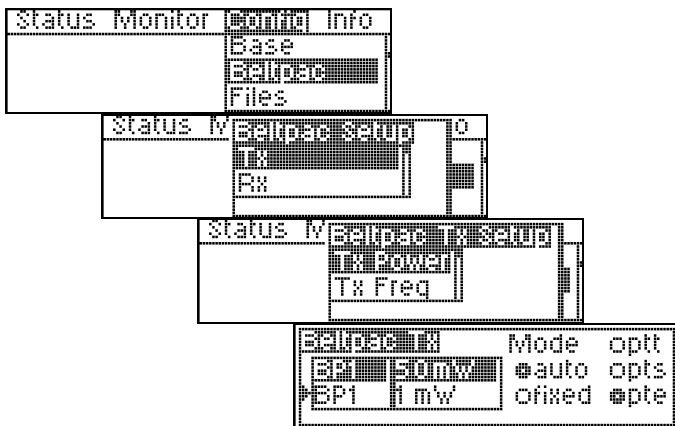

**Belpac Transmitter Power:**

Select the desired Belpac and its transmitter power level (1, 10, 50 or 100mW).

Select the transmit mode and press **ENTER**.

In the **auto** mode, transmitter power will be automatically controlled by the base station, changing between 1 and the specified maximum. In the **fixed** mode, the setting you select will not change.

If you select **ptt**, the Belpac transmitter will be on briefly every few seconds to transmit status. If you select **pts**, the Belpac will only transmit while a user is talking. If you select **pte**, the Belpac will transmit constantly.

If Belpacs are going to share the same transmit frequency, select **pts**. If you select **pts**, you must also select **Ptt Shared** in the Base Receiver Frequency Setup (See page 16).

**NOTE:** Settings for Belpacs BP1-BP16 are stored in the base station. Changes to Belpac settings will not be effective until they are uploaded to the Belpacs. BPCN is the Belpac that is plugged into the base station, therefore changes to its settings are effective immediately.

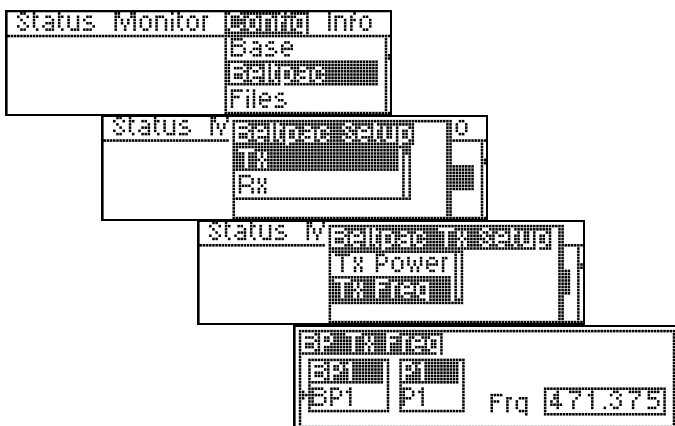

**Belpac Transmitter Frequency:**

Select the desired Belpac and the transmitter frequency for that Belpac's operation (P1-12, S1-12, T1-12 and U1-16). If U1-16 is selected, use the control knob and the up and down arrow buttons to select the desired frequency, in 25kHz increments.

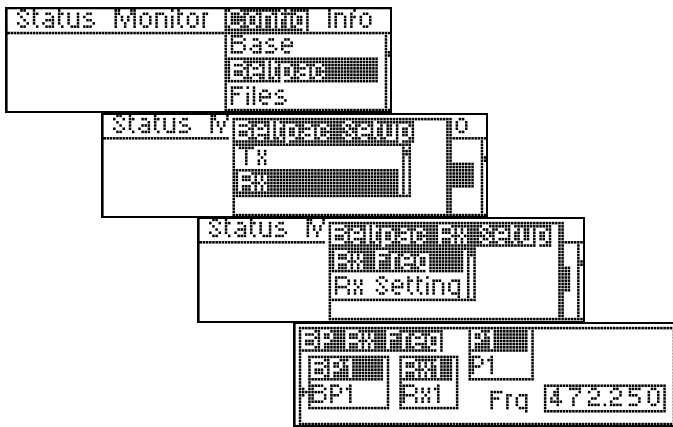

### Beltpac Receiver Frequency:

Select the desired Beltpac and the receiver frequency for that Beltpac's operation (P1-4, S1-4, T1-4 or U1-16). If U1-16 is selected, use the control knob and the up and down arrow buttons to select the desired frequency, in 25kHz increments.

**NOTE:** When only one receiver is present, it will switch between the two frequencies as needed. When two receivers are present, the primary receiver is RX1 and the second receiver is RX2. Normally, RX1 is for intercom CH1. RX2 is for intercom CH2, unless base station TX2 is off or in IFB mode. In that case, both intercom channels go through base TX1 and thus Beltpac RX1. Normally, Beltpac RX1 is the same as base station TX1, and Beltpac RX2 is the same as base station TX2.

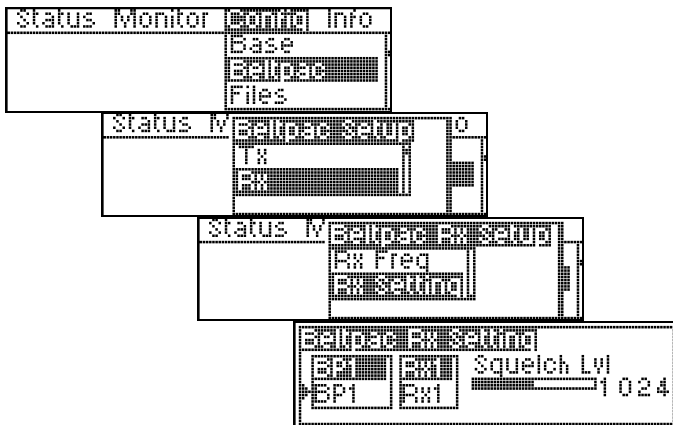

### Beltpac Receiver Squelch Level:

Select the Beltpac and receiver, then use the control knob to adjust its squelch level.

**NOTE:** RX2 squelch adjustment is reserved for a second receiver, when a Beltpac has two receivers. BPCN is the Beltpac that is plugged into the base station, therefore adjustments to its squelch level are effective immediately.

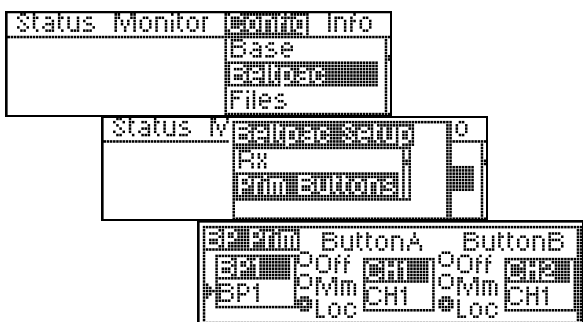

### Beltpac Buttons A and B Setup:

Select the Beltpac and the Mode (Off, Momentary or Lock) for Buttons A and B on each Beltpac.

- CH1 = Talk, Channel 1
- CH2 = Talk, Channel 2
- Both = Talk, both Channels 1 and 2
- Curr = Talk, Current Channel selected
- ISO1 = Talk, to Beltpacs receiving only TX1
- ISO2 = Talk, to Beltpacs receiving only TX2
- ISO = Talk, to Beltpacs receiving both TX1 and TX2
- Page = Talk, Page (stage announce)
- Aux = Talk, Auxiliary Out

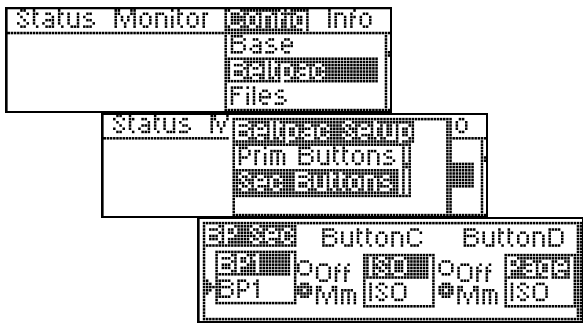

### Beltpac Buttons C and D Setup:

Select the Beltpac and the Mode (Off or Momentary) for Buttons C and D on each Beltpac.

ISO1 = Talk, to Beltpacs receiving only TX1

ISO2 = Talk, to Beltpacs receiving only TX2

ISO = Talk, to Beltpacs receiving both TX1 and TX2

Page = Talk, Page (stage announce)

Aux = Talk, Auxiliary Out

Chan = Toggle Ch1/Ch2

Call = Call Signal

Alert = Alert Signal

**NOTE:** Call Signal only functions when the Talk function is active, and only from a Beltpac to other Beltpacs which have been preset to produce a tone upon receipt of a call signal.

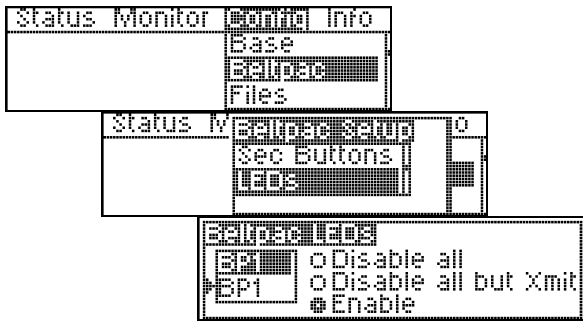

### Beltpac LED Settings:

Select the Beltpac and select the desired functions for the LEDs on each Beltpac.

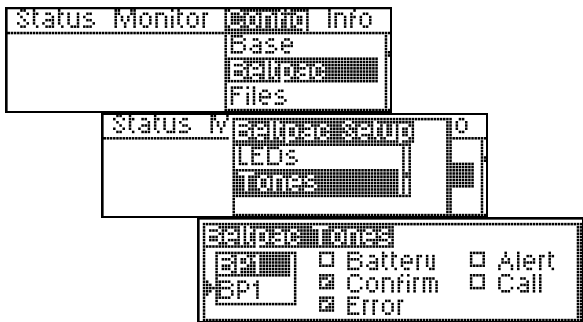

### Beltpac Tone Settings:

Select a Beltpac, then select the events for which you would like tones to sound in that Beltpac user's headset.

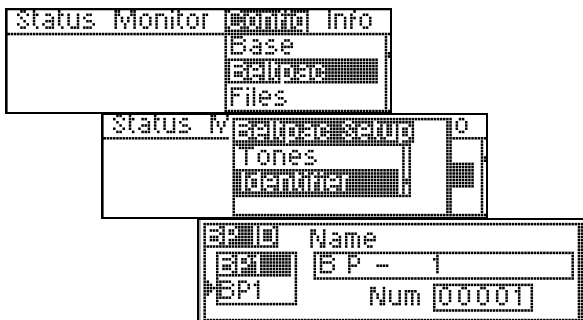

### Beltpac User Identifier Settings:

To assign identification to a Beltpac, such as a user's name, select a Beltpac then use the arrow buttons and selector knob to assign a name and number to each Beltpac.

**NOTE:** Each Beltpac must have a different number, and each assigned number must be programmed into the base, or the base will not recognize the Beltpac.

Names can also be used if desired.

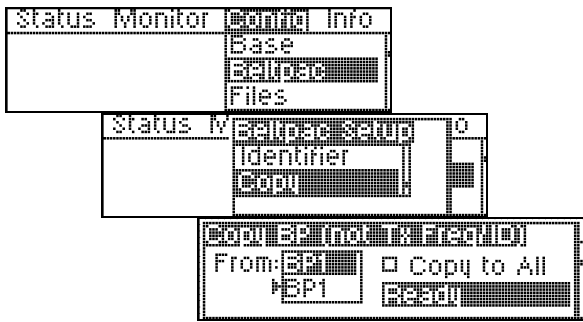

### Copy Beltpac Settings:

To copy settings from one Beltpac to all others for all settings except ID numbers, names and transmit frequencies, select Copy and press the **ENTER** button.

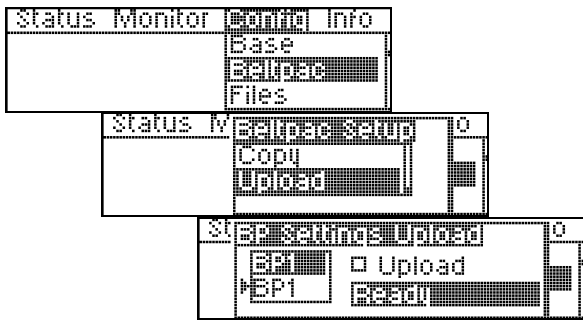

### Upload Beltpac Settings:

To upload all Beltpac settings from the base station to a Beltpac, select a Beltpac then select the upload box and press the **ENTER** button.

**NOTE:** A Beltpac must be connected to the BELTPAC CONFIG connector on the base station front panel to enable uploading of Beltpac settings. To ensure new settings are properly activated, turn the Beltpac off and disconnect it after uploading.

## Saving and Loading Configurations

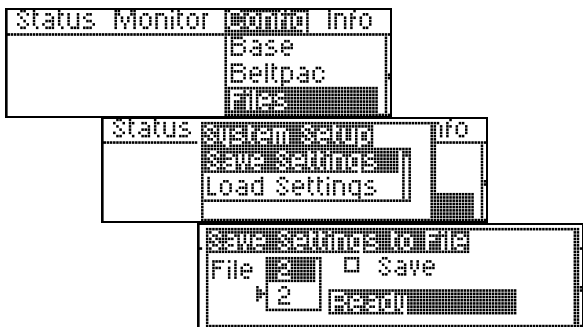

### Save Configuration Settings to File:

To save your configuration settings to a file, select the **File** number then select **Save** and press the **ENTER** button.

**NOTE:** File number 1 is reserved for frequency scans. Files can be saved to 2 through 10.

Be sure to save any changes before turning a base station off. Files are not automatically saved when the power is turned off.

The last file used before a base station is turned off will be used the next time the base station is turned on.

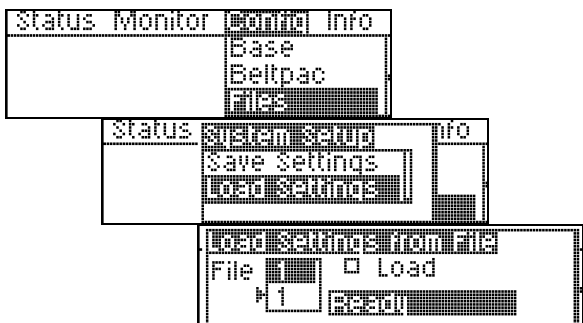

### Load Configuration Settings from File:

To load configuration settings from a previously saved file, select the **File** number then select **Load**. When the settings have been successfully loaded, **Ready** will be replaced by **Busy**, then **Success**.

File 1 always contains the results (and other settings present at the time) of the last frequency scan.

After loading settings, that file becomes the current file and will be used again if the power is turned off.

**NOTE:** After loading a different configuration file, be sure to upload new settings to all Beltpacs.

## Advanced Configuration Settings

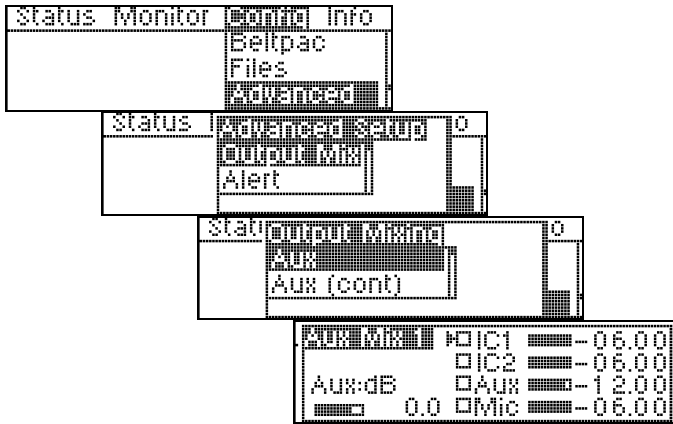

### Auxiliary Output Mixing:

Select the box next to IC1, IC2, Aux and/or Mic to enable input, then use the control knob to adjust output level in 0.25dB or 2.25dB increments for the desired mix.

Place the cursor to the left of the bar below Aux:dB and use the control knob to adjust the overall Aux audio output level in 1.5dB increments.

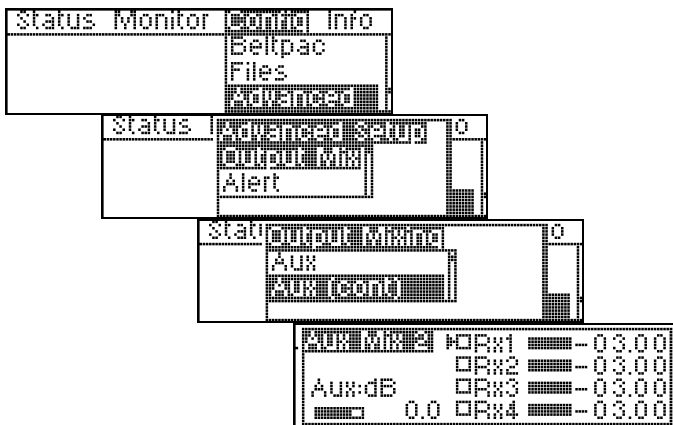

### Auxiliary Output Mixing (continued):

Select the box(es) next to RX1-RX4, then use the control knob to adjust output level in 0.25dB or 2.25dB increments for the desired mix.

Check these boxes only if you want receiver audio continuously fed to the Aux Output. Leave them unchecked for normal operation.

Place the cursor to the left of the bar below Aux:dB and use the control knob to adjust the overall Aux audio output level in 1.5dB increments.

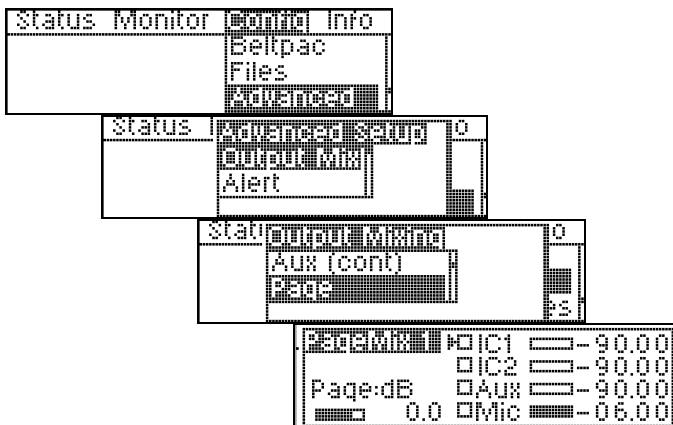

### Page Output Mixing:

Select the box next to IC1, IC2, Aux and/or Mic to enable input, then use the control knob to adjust output level in 0.25dB or 2.25dB increments for the desired mix.

Place the cursor to the left of the bar below Page:dB and use the control knob to adjust the overall Page audio output level in 1.5dB increments.

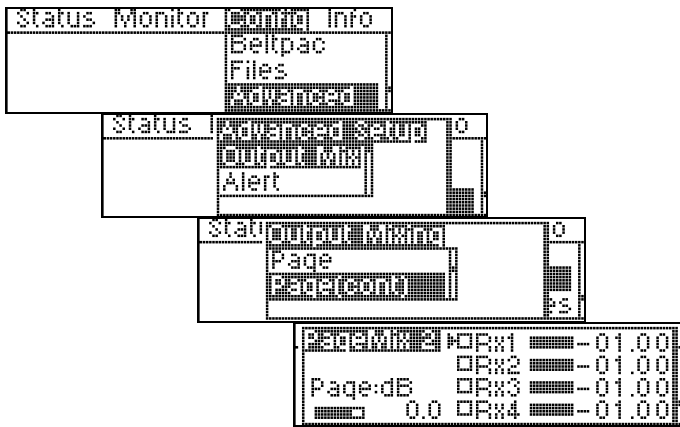

**Page Output Mixing (continued):**

Select the box(es) next to RX1-RX4, then use the control knob to adjust output level in 0.25dB or 2.25dB increments for the desired mix.

Check these boxes only if you want receiver audio continuously fed to the Page Output. Leave them unchecked for normal operation.

Place the cursor to the left of the bar below Page:dB and use the control knob to adjust the overall Page audio output level in 1.5dB increments.



**Intercom Output Mixing:**

Select IC1 or IC2, then select the box next to Aux and/or Mic to enable input. Use the control knob to adjust output level in 0.25dB or 2.25dB increments for the desired mix.

Place the cursor to the left of the bar below IC:dB and use the control knob to adjust the overall IC audio output level in 1.5dB increments.

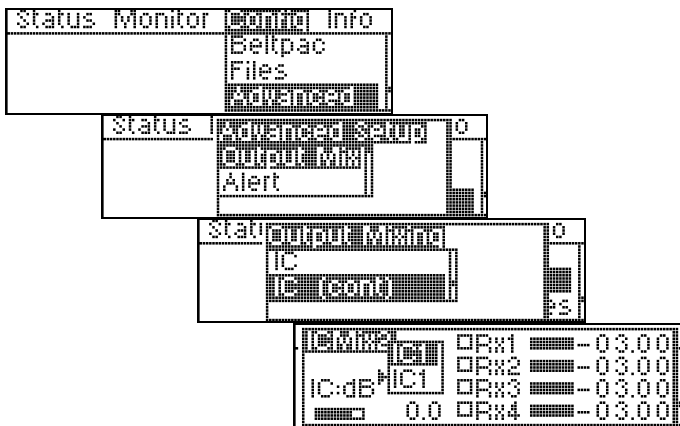

**Intercom Output Mixing (continued):**

Select IC1 or IC2, then select the box(es) next to RX1-RX4 to enable input. Use the control knob to adjust output level in 0.25dB or 2.25dB increments for the desired mix.

Check these boxes only if you want receiver audio continuously fed to the Intercom Output. Leave them unchecked for normal operation.

Place the cursor to the left of the bar below IC:dB and use the control knob to adjust the overall IC audio output level in 1.5dB increments.

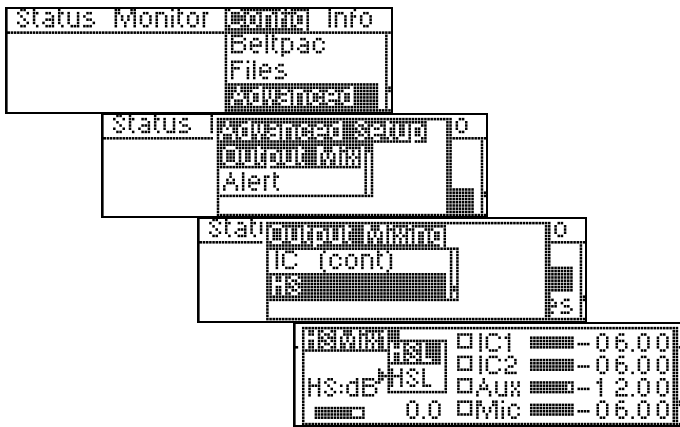

### Headset Output Mixing:

Select HSL (headset left) or HSR (headset right), then select the box next to IC1, IC2, Aux and/or Mic to enable input. Use the control knob to adjust output level in 0.25dB or 2.25dB increments for the desired mix.

Place the cursor to the left of the bar below HS:dB and use the control knob to adjust the overall headset audio output level in 1.5dB increments.

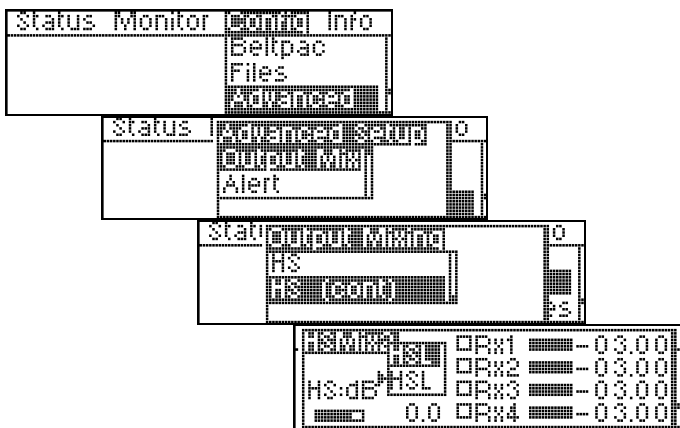

### Headset Output Mixing (continued):

Select HSL (headset left) or HSR (headset right), then select the box(es) next to RX1-RX4 to enable input. Use the control knob to adjust output level in 0.25dB or 2.25dB increments for the desired mix.

Check these boxes only if you want receiver audio continuously fed to the Headset Output. Leave them unchecked for normal operation.

Place the cursor to the left of the bar below HS:dB and use the control knob to adjust the overall headset audio output level in 1.5dB increments.

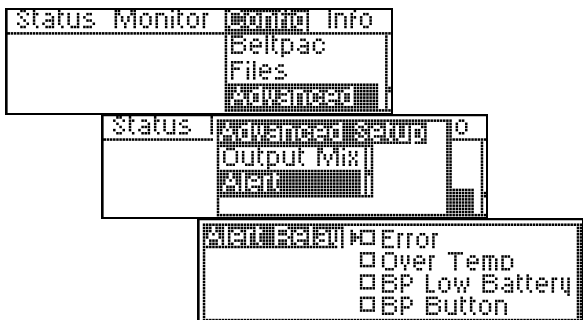

### Alert Settings:

To set the **Alert** relay to close under the desired conditions select any or all of the boxes by moving the cursor to a box and pressing the **ENTER** button. If no boxes are checked, the alert relay will not be used.

**NOTE:** **Error** indicates the base station detects an error condition. **Over Temp** indicates the internal base station temperature is excessive. **BP Low Battery** indicates that any Beltpac in the system has a low battery. **BP Button** indicates any Beltpac button that has been programmed as an alert button.

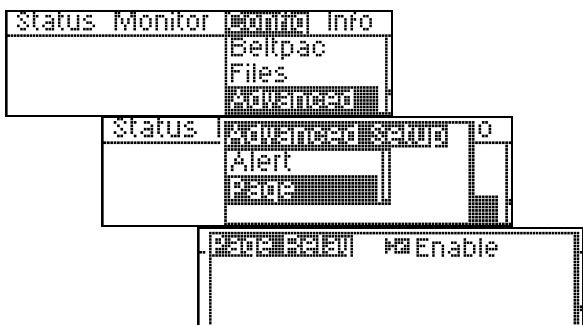

### Page Settings:

To activate the page feature, select **Enable** and press the **ENTER** button.

**NOTE:** If the page relay is not enabled and a Beltpac page button is pushed, a reject tone will be heard in the Beltpac's headset.

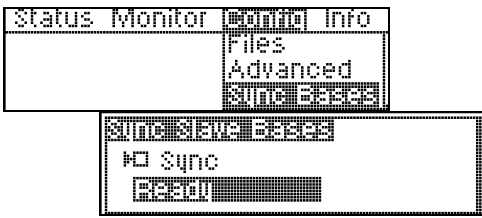

### Synchronize Base Station Settings:

To configure synchronized base station settings, press the **ENTER** button.

**NOTE:** This only pertains to systems with Master and Slave base stations. All Beltpac settings are done in the Master base station. Synchronizing the Slave bases will cause all settings from the Master base station to be transferred to the Slaves.

## Information Displays

Information displays provide information about the base station and its current configuration settings file, and testing capability for transmitter and receiver sub carriers.

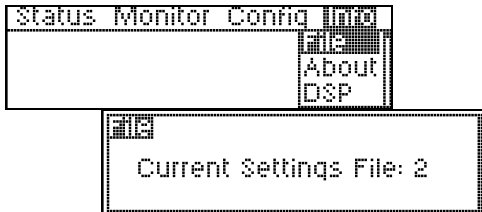

The **File** number displayed is for current configuration settings. It was the settings file being used the last time the base station was turned off, or the last settings file you saved since the base station was turned on.

This is the file that will be used next time the base station power is turned on.

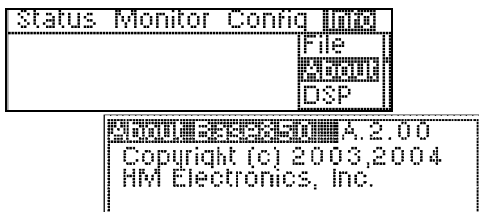

**Base station software version** number and date are displayed.

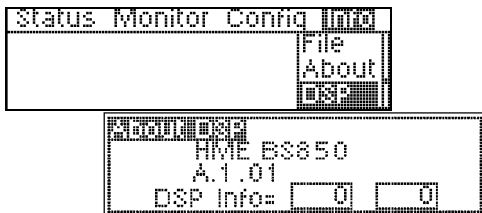

**DSP software version** number is displayed.

## Diagnostic Tests

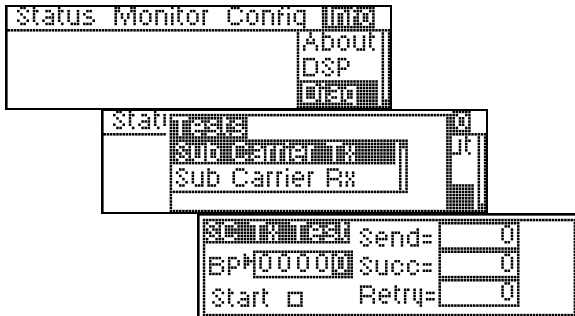

To perform a **Sub Carrier Transmitter Test**, with the cursor at the **BP** box, enter a Beltpac ID number then select **Start**. Let the test run for a few seconds then press the **ENTER** button to stop it. The results will be shown at the right side of the display.

**NOTE:** The Beltpac must be turned on and set to the PTT or PTE transmit mode.

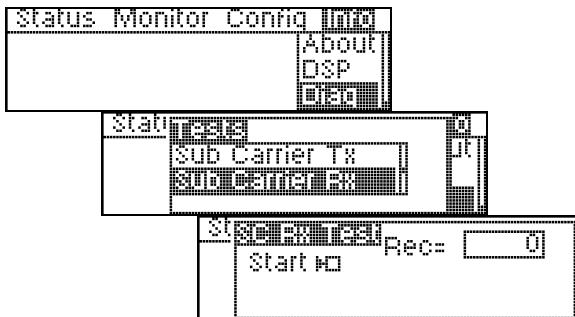

Press the Beltpac C and D buttons on a Beltpac simultaneously. To perform a **Sub Carrier Receiver Test**, select **Start** then press the **ENTER** button.

After completing the test, be sure to turn off the Beltpac. It will remain in the test mode until it is turned off.

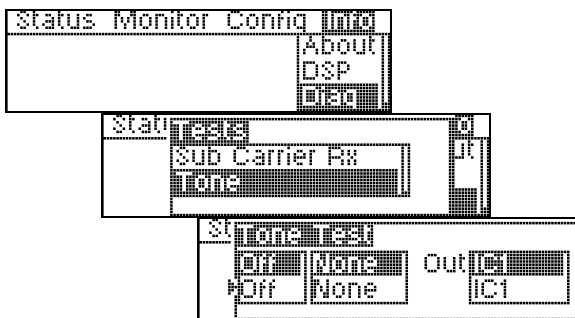

To use the internally generated **Tone Test** function, select the waveform type (Off, Sine, Triangle, Square or Impulse), frequency (50, 100, 300, 400, 700, 1kHz, 3kHz, 4kHz, 7kHz, 10kHz or 12kHz) and output (IC1, IC2, TX1, TX2, AUX OUT, Page, HSR, HSL, All HS, All TX or All).

To turn off the internal **Tone** generator, select **Off** in the waveform type list.

**NOTE:** Due to the digital sampling approach, the triangle waveform will not be smooth above 1 kHz. The square waveform will have jitter above 4 kHz and always has some ringing on the edges.

## ***ADVANCED CONFIGURATION***

Because of its advanced digital signal processing, the PRO850 is very flexible and can be configured to fit the needs of any installation. This section covers some of the available configurations.

---

### **Auxiliary Input and Output Functions:**

The base station auxiliary input and output are used for different purposes depending on the system configuration. In Single, Not Distributed mode (see page 15), the auxiliary input can be mixed with other sources and delivered to any output. This allows an input such as program audio to be fed to all Beltpac users, wired intercom users, or simply monitored by the local headset. In this mode, the auxiliary output may be used as a secondary paging channel (without relay contacts) when Beltpacs are configured for Talk Aux, or as an output to monitor any combination of inputs.

When the base is configured for Single, ISO+ mode (see page 15), the auxiliary input and output work together as an additional isolated four-wire intercom channel. Any input is delivered to all Beltpac users on both transmitters. Any Beltpac user pressing an ISO button will be heard through the auxiliary output.

In Master/Slave modes, the auxiliary input and output are used to distribute receiver audio from the Slaves up to the Master. See the section on Cascading Bases for more information.

---

### **Single Transmitter Two-Channel Operation**

If desired, a single transmitter may be used to distribute both intercom channels to Beltpac users. This allows users to listen to both intercom channels simultaneously and still be able to select talk on a particular channel. Because the mixing takes place inside the base station, all users hear the two channels in the same combination (Beltpac auxiliary volume controls are not used). If users need to adjust the two channels separately, two transmitters and optional second receivers in the Beltpacs are required.

To configure the system for single transmitter operation, first disable one transmitter by selecting Off in the Base Tx Setup screen (see page 13). Then configure all Beltpacs so that both receiver frequencies are set to the one transmit frequency. For example: If the base transmitter is set to 508.250 MHz, set both Beltpac RX1 and RX2 to 508.250 MHz. The indicator LED's on the Beltpacs will continue to indicate which channel is the user's talk channel. The base station DSP will automatically mix both intercom channels into the one transmitter.

### **IFB Transmitter Operation**

In a PRO850 system equipped with dual receiver Beltpacs, the system may be configured to act as an IFB transmitter. When configured in this way, dual receiver Beltpac users will hear all intercom audio through the primary receiver and IFB audio through the second receiver. Users with single receiver Beltpacs will hear all intercom audio, but will not hear the IFB channel.

To configure the system for IFB operation, first set Transmitter 2 by selecting IFB in the Base Station Transmitter Power screen (see page 13). Second, choose an audio source for Transmitter 2 and enable it in the Base Station Transmitter Output Mix Levels screen. Then configure any single receiver Beltpacs for single frequency operation as described under *Single Transmitter Two-Channel Operation*. Finally, configure the dual receiver Beltpacs so that RX1 is tuned to the same frequency as base transmitter 1 and RX2 is tuned to the same frequency as base transmitter 2.

Once a base transmitter has been set to IFB mode, all intercom audio will be automatically routed through the remaining transmitter. The transmitter set to IFB mode, will only transmit program audio manually assigned to it.

On dual receiver Beltpacs, use the Aux volume control to adjust the relative level of the IFB channel. Press and hold the Aux volume control to mute the IFB channel.

---

## Cascading Multiple Base Stations

Two or three base stations may be cascaded to effectively increase the number of available receivers without increasing the number of base transmitters. Cascaded bases behave like a single base with up to twelve receivers.

In a cascaded system, one base is configured as the Master and the additional bases as Slaves. Only the transmitters in the Master are used. Any transmitters present in the Slaves need to be disabled to prevent interference with this or other systems. Because only the Master transmitters are used, receiver audio from the Slaves must be distributed to the Master for retransmission to other Beltpacs. A data cable connected between the Master and Slaves allows audio routing requests and status to be communicated.

The PRO850 supports two methods of distributing audio from the Slaves to the Master. These are called “Aux Distributed” and “2-Wire Distributed”. Each approach has its own advantages and disadvantages. For a quick temporary setup where not all features are required, “Aux Distributed” is the simplest choice. In a permanent installation where most features are needed, “2-Wire Distributed” is the preferred method.

### Aux Distributed Set Up

The Aux Distributed configuration is simpler than 2-Wire Distributed, but has more feature limitations. ISO+ is not supported in an Aux Distributed configuration. Also, there are restrictions on simultaneous conversations from multiple Beltpacs. For instance, if one Beltpac user on a Slave base is currently talking on intercom channel 1, other users on Slave bases will be unable to talk on channel 2. They will be restricted by the system until the first user finishes. However, they may join in on the conversation on channel 1 or listen to channel 2 without restriction. These restrictions are because only a single audio path exists between the Slaves and the Master. Restrictions are enforced automatically by the system. A user attempting to talk on a restricted channel will hear a busy tone upon pressing the Beltpac button.

To set up the system for Aux Distributed operation, configure one base as Mstr: Aux Dist n Slave(s) (see page 15) and select correct number of Slaves (one or two). Then configure one Slave base as Slave1: AUX Dist. If there is a second base, configure it as Slave2: AUX Dist. Note that there can only be one Slave1 and one Slave2. Connect an audio cable from the auxiliary input of the Master base to the auxiliary output of Slave1. If Slave2 is present, connect an audio cable from the auxiliary input of Slave1 to the auxiliary output of Slave2.

### 2-Wire Distributed Set Up

When a system is configured for 2-Wire Distributed operation, it has most of the features of a stand-alone base. However, the wiring is somewhat more complex and there are still some feature limitations. In this mode, receiver audio from the Slave bases is distributed by way of the auxiliary inputs and outputs as well as the 2-wire intercom lines. This means that the auxiliary inputs and outputs cannot be used for other purposes. Since these inputs and outputs are not available, ISO+ operates differently in this configuration. Only the Master is configured for Mstr: 2-Wire ISO+ 1 Slave or Mstr: 2-Wire ISO+ 2 slvs. The Slaves are left as Slave1 (2): 2-Wire. As soon as the Master is set for this mode, the local headset switches and LED's are disabled and the AUX wired status LED lights. An external 4-wire interface (with appropriate levels) can then be connected to the front panel headset connector. The headset amplifier and microphone preamp are still used. Therefore, the audio levels may need to be matched to the 4-wire line through external devices.

To set the system up for 2-Wire Distributed operation, configure the Master base as either Mstr: 2-Wire or Mstr: 2-Wire ISO+ (with the appropriate number of Slaves). Then configure the Slaves as Slave1 (2): 2-Wire. **NOTE:** Be sure to save settings separately on the Master and Slave bases.

Connect audio cables to the auxiliary inputs and outputs as described for Aux Distributed set up. Connect 2-wire lines between the bases as needed. Two lines are required if Clear-Com lines are used, but only one is needed for RTS. If the system is to be connected to a hardwired intercom system through the 2-wire interface, do that as well. Be sure that all bases are configured for the same type of 2-wire line (Clear-Com or RTS).

If no hardwired system is to be used or the hardwired system uses the 4-wire interfaces, it will be necessary to terminate the 2-wire lines. External 200-Ohm terminators may be used or the line may be terminated internally on the Master. To do this, remove the base station cover and move the jumpers at JP4 and JP5 to short pins 1 and 2. Be sure to restore them to their original positions before connecting the base to an existing 2-wire system. With a 4-wire system, it will also be necessary to connect the 4-wire lines (outputs only) of the Slave bases to the intercom system.

## Common Configuration

Some aspects of a cascaded base system are common to both types of audio distribution. These include the data cable connection and parts of the system configuration. Connect a data cable from the external control connector of the Master to the Slaves (see wiring diagram on page 7). If there is only one Slave, a standard Ethernet crossover cable may be used to connect the Master to Slave1. Note that the external port is an RS422 serial connection not Ethernet. For this reason, an Ethernet hub cannot be used. It is important that the correct number of Slaves be specified in the Master configuration. If this number is incorrect, the system may not function correctly or may have degraded response times.

If a PC is going to be used for configuration, connect it to the Master base station. All Slave base settings are accessible through the Master.

Once the connections are made, configure the receivers on each base and save the settings separately on each base station. Then configure the transmitter and Beltpac settings at the Master base. Be sure to disable the transmitters in the Slave(s) by turning them off in the Tx Power screen (see page 13). Do not make Beltpac configuration changes at the Slaves, as they will be overwritten by the settings from the Master. Once all settings are complete, save them again and upload them to the Beltpacs (from the Master base). Then synchronize the settings from the Master (see page 24) and save the settings at the Slaves.

If paging will be used, connect the page outputs of each base to separate inputs on the paging amplifier and connect page relays in series or parallel as required. If only Beltpacs on a single base will be allowed to page, it is only necessary to connect that base to the paging amplifier.

---

## Alert Relay Operation

Unlike the dedicated page relay, the alert relay is configurable for various functions. It can be configured to signal an alarm when an undesirable condition exists such as high temperature in the base station or a low battery in a Beltpac. It can also be used as a general purpose output controlled by a button on a Beltpac. The relay can be enabled for any combination of these actions.

As an over temperature alarm, the relay is energized whenever the base station internal temperature exceeds 60°C. It remains energized until the temperature falls below 55° C. The base will not shut down automatically due to over temperature conditions. However, operating the system above the specified ambient temperatures may result in improper operation or damage.

When enabled to alert on low battery conditions, the relay will energize when any Beltpac reports a low battery condition. It will remain energized until all Beltpacs report good battery voltage. Thus, even if the battery runs down completely and the Beltpac stops operating, the alert condition will still exist until the battery is replaced and that Beltpac resumes operation.

If a general purpose Beltpac triggered output is desired, the BP Button condition should be enabled. In this case, the relay will energize whenever a user presses their alert button. The relay remains energized until the user releases the button. As confirmation, the Beltpac user will hear the alert tone (if enabled) in the headset while pressing the button.

**NOTE:** Beltpac firmware prior to version A.2.00 requires that the unit be in talk mode prior to pressing the Alert button. Newer models do not have this requirement. Use PDA850 for Beltpac status, as shown on page 41.

The relay can also be enabled to signal fault conditions in the base. Faults of this type are catastrophic and require cycling power or repair.

# ***BELTPAC OPERATION***

---

## **Controls and Buttons**

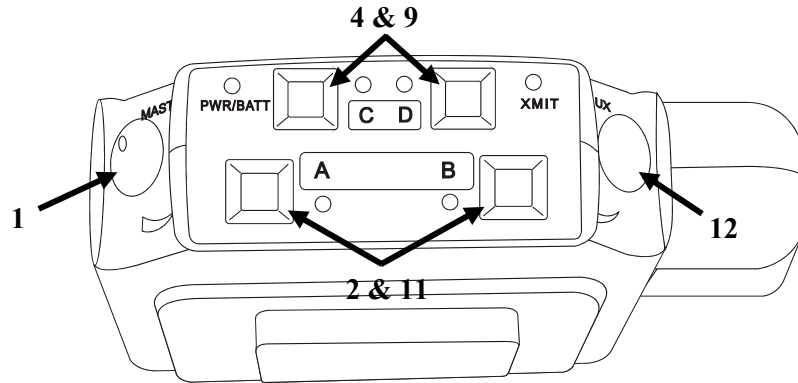

### **1. Master On/Off Volume Control**

Turns Beltpac on and off.

Controls volume levels and beep intensity.

Press and hold control button in to mute primary receiver input.

### **2 & 11. A and B Buttons**

Perform functions set up in Beltpac programming. Refer to Equipment Setup in Section 2.

If set up for Lock function, press and release button in less than one second to lock on.

Press and hold for momentary function, to remain on only while button is held.

If set up for Momentary function, button will remain on only while held. Lock feature cannot be used.

Either or both of these buttons can be turned off in Beltpac setup.

### **4 & 9. C and D Buttons**

Perform functions set up in Beltpac programming. Refer to Equipment Setup in Section 2.

Only momentary function can be used. If set for momentary function, button will remain on only while held. C and D buttons have no lock function.

Either or both of these buttons can be turned off in Beltpac setup.

### **12. Auxiliary Volume Control**

Controls mix levels of auxiliary input or an optional second receiver.

Press and hold control button in to mute auxiliary input or second receiver.

---

## Indicator Lights

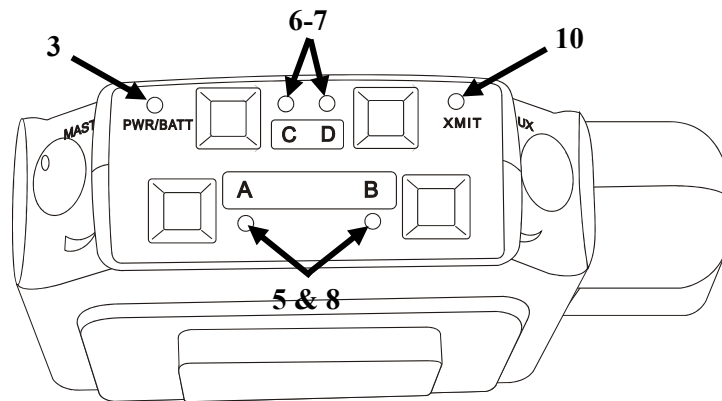

### 3. Power/Battery Light

Remains lit when power is on. Green = good batteries  
Amber = low batteries  
Red = nearly dead batteries

### 6-7. C and D Lights

On while any functions programmed into C and D buttons are activated.

### 10. Transmit Light

On steady red while Beltpac is transmitting.

### 5 & 8. A and B Channel Indicator Lights

A-green while listening on Channel 1.

A-red while talking on Channel 1.

B-green while listening on Channel 2.

B-red while talking on Channel 2.

A & B both green while listening to both channels (requires optional second receiver).

A or B blinking green indicates current channel on dual-receiver Beltpac.

If indicator lights (LEDs) are configured on, holding the C and D buttons while turning the Beltpac power on will disable them until the next time the Beltpac is turned off and on again.

If LEDs are configured off, holding the C and D buttons while turning the Beltpac power on will turn the LEDs back on until the next time the Beltpac is turned off and on again.

If LEDs are configured off, when normally turning the Beltpac power on, all LEDs will blink on momentarily.

---

## Connectors and Adjustment

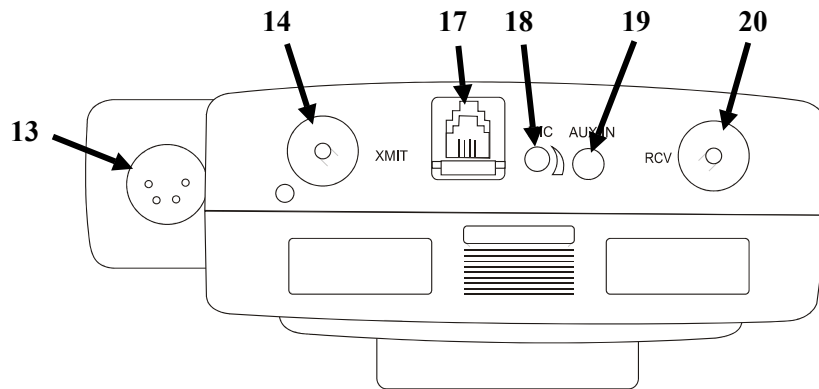

### 13. Headset Connector

XLR type connector.

### 14 & 20. Antenna Connectors

Transmitter antenna connector has color dot (or none), matching color band (or none) on transmitter antenna. Receiver antenna connector has color dot (or none), matching color band (or none) on receiver antenna.

Screw antennas securely into connectors.

### 17. RMT Connector

Used for interconnect programming cable to base station, for uploading Beltpac configuration settings and frequency scans.

**CAUTION:** *Beltpac should not be turned off and back on while connected to base station or controller malfunction may occur. If this happens, unplug the connector, turn the Beltpac power off, wait at least one second and turn the power back on. An ordinary telephone handset cable may be used to connect the Beltpac to the base station.*

Interconnect cable has RJ-10 type connectors.

### 18. Headset Microphone Gain Adjustment

Adjusts headset microphone gain  $\pm 10$ dB.

**NOTE:** Beltpac automatically detects electret or dynamic microphone.

### 19. Auxiliary Input Connector

1/8 inch jack receptacle for line level monaural audio source.

If the Beltpac includes a second (optional) receiver, plugging into this location will disconnect the second receiver and connect the auxiliary input device in its place.

---

## Batteries

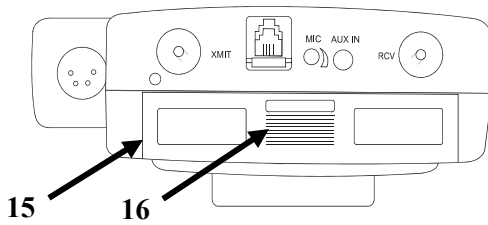

15. Battery Compartment Cover

16. Battery Cover Thumb grip

### To change batteries:

Place your thumb on the battery cover thumb grip and pull back on the battery compartment cover to open the battery compartment. Carefully flip the cover up and slide it to the back of the opening and push it slightly downward to release the battery sled into your hand.

Remove the six 1.5V AA batteries from the sled and replace them with six fresh ones.

Carefully slide the battery compartment cover back over the compartment until its latches securely in place.

---

## Infrared Window

The infrared window provides capability for interfacing with a PDA for easy PRO850 configuration setups.

Optional HME PDA850 software is required.

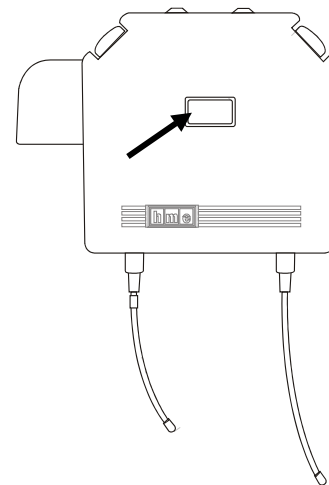

---

## Dual-Receiver Operation

A Beltpac equipped with the optional second receiver operates a little differently from a single-receiver Beltpac. When a user switches from Channel 1 to Channel 2 on a single-receiver Beltpac, the microcontroller inside the Beltpac automatically switches the receiver frequency from RX1 to RX2. That means that it is not normally possible for the user to hear both intercom channels at the same time. With a dual-receiver Beltpac, there is no need to change frequencies and the primary receiver always stays tuned to RX1 and the second receiver stays tuned to RX2. The user is then able to hear both intercom channels at the same time and adjust the relative volume between them.

This difference makes the operational characteristics of a dual-receiver Beltpac slightly different from those of a single-receiver Beltpac. On a single-receiver Beltpac, only one of the A or B indicator lights will be on indicating the current channel. On a dual-receiver Beltpac, both A and B indicator lights will be on indicating that both receivers are active. If one of the buttons is programmed to toggle between channels, the current channel indicator will blink. An additional feature of the dual-receiver Beltpacs is the ability to talk on both intercom channels at the same time.

---

## Troubleshooting

If a Beltpac fails to communicate with the base, check the following items

- Be certain it has fresh batteries, is on, and is within range of the base station.
- Verify that the Beltpac receiver frequencies, RX1 and RX2 are set to the corresponding base transmit frequencies. Beltpac RX1 should always be set to base TX1 frequency unless TX1 is disabled or not present. Likewise, RX2 should always be set to base TX2 frequency unless TX2 is disabled or not present.
- Check the Beltpac transmit frequency and be certain that one receiver on the base is tuned to that frequency and is enabled.
- Be certain the Beltpac has a valid numeric ID between 1 and 65279 and that the base has the same ID set for one of the sixteen Beltpacs (see page 20). If a Beltpac attempts to talk on a base that does not have its ID, the base will reject the Beltpac.
- Be certain the Beltpac is several feet away from the base receive antenna. The base receiver may be overloaded if a Beltpac operating at full power is too close.

The following abnormal conditions can be indicated by the LED's on the top of the Beltpac.

- Both C and D indicators on continuously without any buttons pressed: The Beltpac is in test mode. Turn the power off; wait one second; and turn the power back on.
- Both A and B indicators blinking red simultaneously: An internal memory failure has been detected. Return the Beltpac for service.
- Both A and B indicators blink green simultaneously: Factory settings checksum is invalid. Return the Beltpac for service.
- Both A and B indicators blink orange simultaneously for five seconds: User settings have been lost. Connect the Beltpac to a base station and reconfigure. If the condition reoccurs, the Beltpac may require service.
- All indicators blink rapidly: Batteries are too low for continued operation. Replace batteries.

## SECTION 4. PRO850 SYSTEM SOFTWARE

PC850 is a Microsoft Windows® application which enables the user to make all PRO850 base station and Beltpac configuration settings on a PC and save the settings to files. An RS-232 interface cable must be used to connect the PRO850 base station to the PC in which PC850 software is installed.

PDA850 is a Palm OS® application for remote configuration of individual Beltpacs. It uses an IrDA (infrared light) link to communicate with Beltpacs for the purpose of retrieving and changing user settings. All settings except the Beltpac ID and name can be changed with PDA850.

### PC850 Installation

#### Minimum Requirements for Use of PC850 Software

- IBM compatible PC with a Pentium™ microprocessor
- Minimum of 32 megabytes RAM
- Minimum of 100 megabytes available hard disk space
- One available RS-232 serial port
- Serial interface cable appropriate for your PC (See Section 2.1)
- Microsoft Windows™ 98, Windows™ NT4.0 Svc Pac 3, Windows™ 2000, Windows™ ME or Windows™ XP
- Familiarity with Windows™ operating system
- Internet Explorer 5.5 or later

**NOTE:** Before installing PC850, close all other programs that are open.

To install PC850 under Windows 98, Windows NT4.0 Svc Pac 3, Windows 2000, Windows ME or Windows XP, follow the instructions below.

To install PC850 for Windows NT/2000, you must be a System Administrator. For Windows NT/2000, if you have installed this product for multiple users, you may give authorization to all PC850 users at once. To do this, log into the computer as System Administrator and install PC850 according to these instructions. After successful installation, all users will have access to PC850. To be able to run PC850, each user must have "Read, Write and Execute" permission for the **ProgramFiles\HME\PC850** directory.

1. Insert the CD into a selected CD-ROM drive.
2. In Windows Explorer, double click on the CD-ROM drive where the CD is inserted.
3. Double click on the **setup.exe** file, and the PC850 installation will begin.

Proceed as instructed on the installation screens. When the installation has been completed, select Finish to end the installation process.

---

## PC850 Operation

To open the PC850 software, double click on the PC850 icon on your desktop screen.

When the PC850 opens, the screen below will appear on your PC.

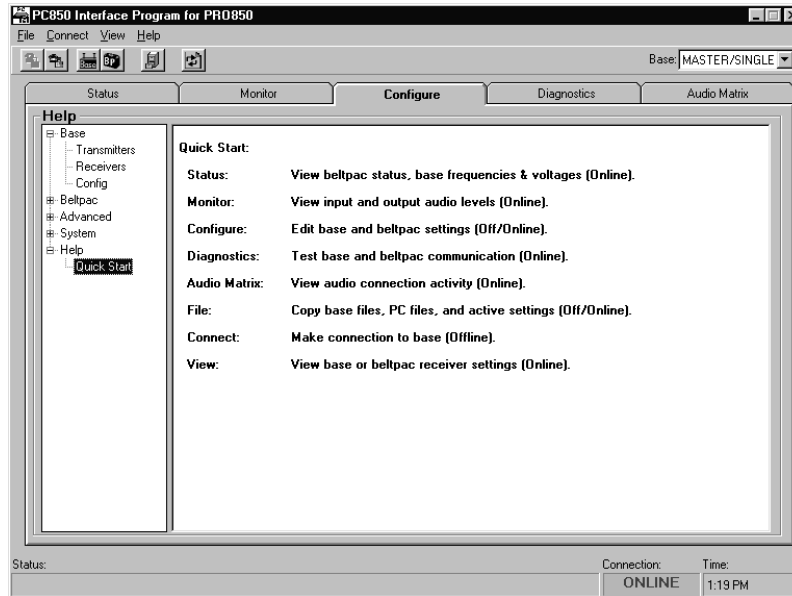

Select the **Status**, **Monitor**, **Configuration** or **Information** tab with your cursor. The respective screen will appear with all the same functions and system settings that are available on the PRO850 base station. Place your cursor over the desired setting on the screen and a drop-down menu will appear with the applicable selections or information.

---

PC850 can be operated in either of two modes: Offline or Online. Offline means that the program is operated without any connection to a PRO850 base station. In this mode, the only screens that can be accessed are under the Configuration tab. This allows a user to set up configurations and save them to disk so that they can be loaded into the base station later. While offline, the connection status indicator on the status bar at the bottom of the window will be red. Online means that the base station is connected to the PC and that a logical connection between the two has been established.

To switch to online mode, first be sure that an appropriate cable is connected between the base station and the PC. Then select Connect from the Connect menu or press the Connect button on the toolbar. This will open the Connect to System dialog box. There, choose the appropriate connection and click Connect. Once online, the connection status indicator will be green.

The first three tabs on the PC850 window match the first three menus on the BS850 LCD screen: Status, Monitor, and Configure. The fourth tab, Diagnostics, matches the base station diagnostics menu item under the Info menu. The functions available on each tab match those available on the base station itself. Depending on the speed of the PC, it may be necessary to click the Freeze Screen button at the bottom of the window to make it possible to move away from the Status or Monitor tabs. It is necessary to freeze these screens if you wish to select a menu item while displaying Status or monitoring audio levels.

When two or three bases are tied together in a cascaded configuration, the computer is connected to the Master base. PC850 can access the settings of each base by selecting the appropriate base from the drop-down list in the upper right portion of the screen.

A particularly useful feature of PC850 is the ability to display (and alter) the audio connection matrix. This window shows all possible and active audio connections. To open the window, select Audio Connection Matrix from the View menu. Once open, the window will display all active connections as check marks beside a green square. As connections change, the screen will be updated with the new information. To force a manual

connection, simply check the desired box(es). To break a connection, uncheck the desired box(es). Note that two types of connections are shown: Manual connections and dynamic connections. Manual connections result from configuration settings or functions. Dynamic connections result from Beltpac operations or the front panel Talk button. Checking a box in the window always results in a manual connection. Manual connections are not overridden by dynamic operations. However, clearing a connection manually does not prevent a later dynamic or manual connection from being established. Note that the Audio Connection Matrix window can only be opened while PC850 is “online”.

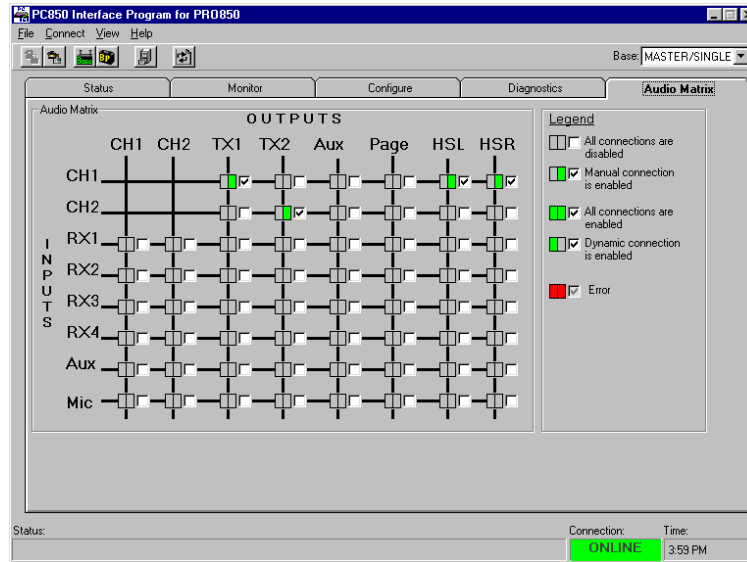

PC850 may be used to copy files between the PC and the base, between files on the base, and between bases in a cascaded configuration. To copy files, select Settings, Copy Settings from the File menu or click the filing cabinet button on the tool bar. The screen shown below will appear:

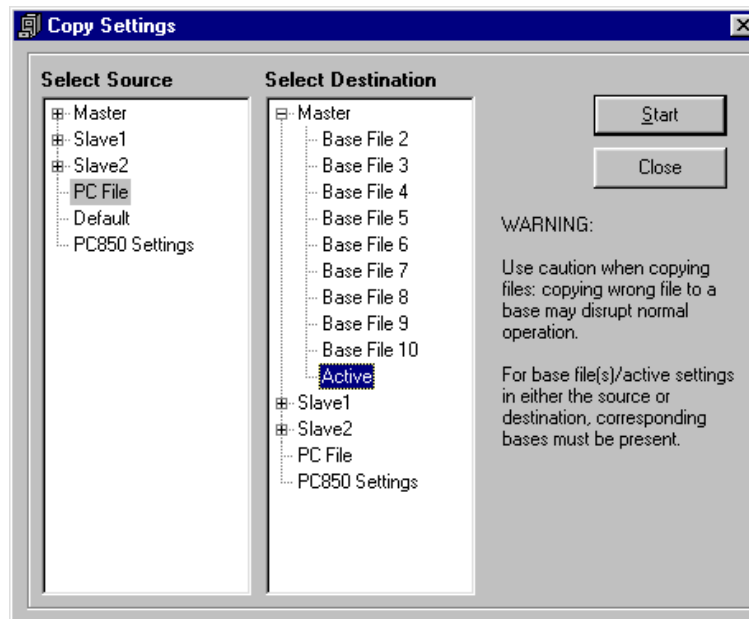

Select the source of the settings on the left side and the destination on the right side and then click Start. If PC FILE has been chosen for source or destination, another dialog box will open for you to specify the file name.

## SECTION 5. PDA850 INSTALLATION

### Minimum Requirements for Use of PDA850 Software

- Palm compatible PDA with IrDA port
- Minimum of 1 megabyte of available RAM
- Palm OS 3.5 or later
- A PC with the ability to Hot Sync to the PDA

There are two versions of PDA850 on the CD. One version is for devices running Palm OS 3.5 – 4.x. The other version is for devices running Palm OS 5.x. To run PDA850 on a Palm OS 5-based device, it is first necessary to obtain the AppForge Crossfire Client (Booster) application. This can be purchased from AppForge directly at [www.appforge.com](http://www.appforge.com). For OS 4.x and earlier devices, the Booster application is included in the PDA850 installation program and does not need to be purchased or downloaded.

**NOTE:** Not all Palm OS 5 PDA's will work with PDA850 software. PDA's based on a Texas Instruments OMAP 3xx ARM processor cannot run PDA850. This is due to a hardware limitation within the TI processor. Please contact your distributor for a list of known devices that can run PDA850.

### PDA850 Installation

- Insert the CD into a selected CD-ROM drive.
- In Windows Explorer, double click on the CD-ROM where the CD is located.
- Locate the folder containing the appropriate version of PDA850 for your PDA.
- Double click on the PDA850-Install.prc file. Hot Sync Manager should then add the file to your install list for the next Hot Sync. If this does not happen, you will need to start the Palm Install Tool, locate the file above and add it to the list.
- Hot Sync the PDA. Once the Hot Sync is finished, the installer will run and extract the necessary files into the PDA.

### PDA850 Operation

To open PDA850, tap the PDA850 icon. After a short delay, the Beltpac Status screen will be displayed. To retrieve settings from a Beltpac, point the IrDA port on the PDA at the window on the Beltpac and tap Get All.

Be careful not to move the Beltpac or the PDA significantly during the transfer. Once PDA850 has transferred all settings, it will give a double beep and disconnect the link. PDA850 can only communicate with a Beltpac if the user is not in talk mode. If you see a timeout error message, check the Beltpac to be sure that none of the indicators (A, B, C, or D) are red. Also check that the PDA and Beltpac are in line and no excessively bright lights are shining on either one.

PDA850 can store a single Beltpac configuration in the PDA memory. Settings stored in the PDA may be retrieved by tapping Load. These settings may be edited and then uploaded to the Beltpac or saved again.

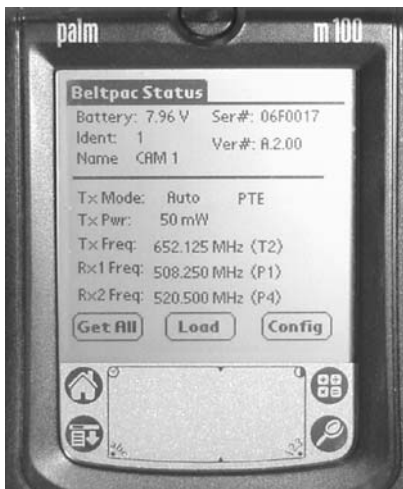

If you wish to change configuration settings, tap Config to open the Beltpac Config screen. Choose any one of the categories and tap it to go to that screen. To save the settings in the PDA, tap Save. To upload all of them to the Beltpac, tap Set All. Individual categories of settings can be uploaded on their separate screens.



# END-USER LICENSE AGREEMENT FOR HME PRO850 SYSTEM SOFTWARE

**IMPORTANT — READ CAREFULLY:** This HME End-User License Agreement ("AGREEMENT") is a legal agreement between you (either an individual or a single entity) and HM Electronics, Inc. ("HME") for the HME software product PRO850 System Software, which includes computer software and may include associated registration files, media, printed materials, sample documents, and "online" or electronic documentation ("SOFTWARE PRODUCT"). The SOFTWARE PRODUCT also includes any updates and supplements to the original SOFTWARE PRODUCT provided to you by HME. Any software provided along with the SOFTWARE PRODUCT that is associated with a separate end-user license agreement is licensed to you under the terms of that license agreement.

By installing, copying, downloading, accessing, or otherwise using the SOFTWARE PRODUCT, you agree to be bound by the terms of this AGREEMENT. If you do not agree to the terms of this AGREEMENT, do not install or use the SOFTWARE PRODUCT; you may, however, return it to your place of purchase for a full refund.

## SOFTWARE PRODUCT LICENSE

**The SOFTWARE PRODUCT is protected by copyright laws and international copyright treaties, as well as other intellectual property laws and treaties. The SOFTWARE PRODUCT is licensed, not sold.**

### 1) GRANT OF LICENSE. This AGREEMENT grants you the following rights:

**a) Applications Software.** As an individual, you are granted a world-wide non-exclusive license, which includes only the right to install, use, access, display, run, or otherwise interact with ("RUN") one copy of the SOFTWARE PRODUCT, or any prior version for the same operating system, on a single computer. If you are an entity, you are granted the right to designate one individual within your organization to have the right to use the SOFTWARE PRODUCT in the manner provided above.

**b) Storage/Network Use.** As an alternative to installing the SOFTWARE PRODUCT on a dedicated computer, you may store or install the SOFTWARE PRODUCT on a storage device, such as a network server, used only to RUN the SOFTWARE PRODUCT on your other COMPUTERS over an internal network; however, you must acquire and dedicate a license for each separate COMPUTER on which the SOFTWARE PRODUCT is RUN from the storage device. A license for the SOFTWARE PRODUCT may not be shared or used concurrently on or by different COMPUTERS.

**c) Reservation of Rights.** All rights not expressly granted are reserved by HME.

### 2) DESCRIPTION OF OTHER RIGHTS AND LIMITATIONS.

**a) Limitations on Reverse Engineering, Decompilation, and Disassembly.** You may not reverse engineer, decompile, or disassemble the SOFTWARE PRODUCT.

**b) Separation of Components.** The SOFTWARE PRODUCT is licensed as a single product. Its component parts may not be separated for use on more than one COMPUTER.

**c) Trademarks.** This AGREEMENT does not grant you any rights in connection with any trademarks or service marks of HME.

**d) Rental.** You may not rent, lease, or lend the SOFTWARE PRODUCT.

**e) Support Services.** HME may provide you with support services related to the SOFTWARE PRODUCT ("Support Services"). Use of Support Services is governed by the HME policies and programs described in the user manual, in "online" documentation, and/or in other HME-provided materials. Any supplemental software code provided to you as part of the Support Services shall be considered part of the SOFTWARE PRODUCT and subject to the terms and conditions of this AGREEMENT. With respect to technical information you provide to HME as part of the Support Services, HME may use such information for its business purposes, including for product support and development. HME will not utilize such technical information in a form that personally identifies you.

**f) Software Transfer.** The initial licensee of the SOFTWARE PRODUCT may make a one-time permanent transfer of this AGREEMENT and SOFTWARE PRODUCT only directly to an end user. This transfer must include all of the SOFTWARE PRODUCT (including all component parts, the media and printed materials, any upgrades, this AGREEMENT, and, if applicable, the Certificate of Authenticity). Such transfer may not be by way of consignment or any other indirect transfer. The transferee of such one-time transfer must agree to comply with the terms of this AGREEMENT, including the obligation not to further transfer this AGREEMENT and/or SOFTWARE PRODUCT.

**g) Termination.** Without prejudice to any other rights, HME may terminate this AGREEMENT if you fail to comply with the terms and conditions of this AGREEMENT. In such event, you must destroy all copies of the SOFTWARE PRODUCT and all of its component parts.

**3) UPGRADES.** If the SOFTWARE PRODUCT is labeled as an upgrade, you must be properly licensed to use a product identified by HME as being eligible for the upgrade in order to use the SOFTWARE PRODUCT. A SOFTWARE PRODUCT labeled as an upgrade replaces and/or supplements (and may disable) the product that formed the basis for your eligibility for the upgrade. You may use the resulting upgraded product only in accordance with the terms of this AGREEMENT. If the SOFTWARE PRODUCT is an upgrade of a component of a package of software programs that you licensed as a single product, the SOFTWARE PRODUCT may be used and transferred only as part of that single product package and may not be separated for use on more than one COMPUTER.

**4) COPYRIGHT.** All title and copyrights in and to the SOFTWARE PRODUCT (including but not limited to its code, appearance, structure, organization along with any documents, forms, text, and images incorporated into the SOFTWARE PRODUCT), the accompanying printed materials, and any copies of the SOFTWARE PRODUCT are owned by HME or its suppliers. All title and intellectual property rights in and to the content that may be accessed through use of the SOFTWARE PRODUCT are the property of the respective content owner and may be protected by applicable copyright or other intellectual property laws and treaties. This AGREEMENT grants you no rights to use such content. If this SOFTWARE PRODUCT contains documentation that is provided only in electronic form, you may print one copy of such electronic documentation. You may not copy the printed materials accompanying the SOFTWARE PRODUCT.

**5) BACKUP COPY.** After installation of one copy of the SOFTWARE PRODUCT pursuant to this AGREEMENT, you may keep the original media on which the SOFTWARE PRODUCT was provided by HME solely for backup or archival purposes. If the original media is required to use the SOFTWARE PRODUCT on the COMPUTER, you may make one copy of the SOFTWARE PRODUCT solely for backup or archival purposes. Except as expressly provided in this AGREEMENT, you may not otherwise make copies of the SOFTWARE PRODUCT or the printed materials accompanying the SOFTWARE PRODUCT.

**6) EXPORT RESTRICTIONS.** You agree that you will not export or re-export the SOFTWARE PRODUCT, any part thereof, or any process or service that is the direct product of the SOFTWARE PRODUCT (the foregoing collectively referred to as the "Restricted Components"), to any country, person or entity subject to U.S. export restrictions. You specifically agree not to export or re-export any of the Restricted Components (i) to any country to which the U.S. has embargoed or restricted the export of goods or services, which currently include, but are not necessarily limited to Cuba, Iran, Iraq, Libya, North Korea, Sudan and Syria, or to any national of any such country, wherever located, who intends to transmit or transport the Restricted Components back to such country; (ii) to any person or entity who you know or have reason to know will utilize the Restricted Components in the design, development or production of nuclear, chemical or biological weapons; or (iii) to any person or entity who has been prohibited from participating in U.S. export transactions by any federal agency of the U.S. government. You warrant and represent that neither the BXA nor any other U.S. federal agency has suspended, revoked or denied your export privileges.

**7) NO LEGAL ADVICE.** You agree and acknowledge that HME is not engaged in rendering legal, accounting, or other professional advice. If legal advice or other expert assistance is required, the services of a competent professional person should be sought. Any sample documents included with the SOFTWARE PRODUCT are for illustration only and should not be used as the basis for any transaction or advice.

## 8) MISCELLANEOUS

- a) If you acquired this SOFTWARE PRODUCT in the United States, this AGREEMENT is governed by the laws of the State of California.
- b) If you acquired this SOFTWARE PRODUCT in Canada, unless expressly prohibited by local law, this AGREEMENT is governed by the laws in force in the Province of Ontario, Canada; and, in respect of any dispute which may arise hereunder, you consent to the jurisdiction of the federal and provincial courts sitting in Toronto, Ontario. If this SOFTWARE PRODUCT was acquired outside the United States, then local law may apply.
- c) If you have any questions concerning this AGREEMENT, or if you desire to contact HME for any reason, please write to: HM Electronics, Inc., 14110 Stowe Drive, Poway, California, 92064 U.S.A.

## 9) LIMITED WARRANTY

- a) **LIMITED WARRANTY FOR SOFTWARE PRODUCTS ACQUIRED IN THE U.S. AND CANADA.** HME warrants that (a) the SOFTWARE PRODUCT will perform substantially in accordance with the accompanying written materials for a period of ninety (90) days from the date of receipt, and (b) any Support Services provided by HME shall be substantially as described in applicable written materials provided to you by HME, and HME support engineers will make commercially reasonable efforts to solve any problem issues. Some states and jurisdictions do not allow limitations on duration of an implied warranty, so the above limitation may not apply to you. To the extent allowed by applicable law and not disclaimed in this Agreement, implied warranties on the SOFTWARE PRODUCT, if any, are limited to ninety (90) days.

**CUSTOMER REMEDIES.** HME's and its suppliers' entire liability and your exclusive remedy shall be, at HME's option, either (a) return of the price paid, if any, or (b) repair or replacement of the SOFTWARE PRODUCT that does not meet HME's Limited Warranty and which is returned to HME with a copy of your receipt. This Limited Warranty is void if failure of the SOFTWARE PRODUCT has resulted from accident, abuse, or misapplication. Any replacement SOFTWARE PRODUCT will be warranted for the remainder of the original warranty period or thirty (30) days, whichever is longer. Outside the United States, neither these remedies nor any product support services offered by HME are available without proof of purchase from an authorized international source.

- c) **NO OTHER WARRANTIES.** THE LIMITED WARRANTY ABOVE IS EXCLUSIVE AND IN LIEU OF ALL OTHER CONDITIONS AND WARRANTIES FOR THE SOFTWARE AND DOCUMENTATION. HME AND ITS SUPPLIERS MAKE NO OTHER CONDITIONS OR WARRANTIES, EXPRESS, IMPLIED, STATUTORY OR OTHERWISE, AND EXPRESSLY DISCLAIM ALL OTHER CONDITIONS AND WARRANTIES, INCLUDING BUT NOT LIMITED TO IMPLIED CONDITIONS OR IMPLIED WARRANTIES OF MERCHANTABILITY, FITNESS FOR A PARTICULAR PURPOSE, AND NONINFRINGEMENT FOR THE SOFTWARE AND DOCUMENTATION, TO THE FULLEST EXTENT PERMITTED BY APPLICABLE LAW.

- d) **LIMITED LIABILITY.** TO THE MAXIMUM EXTENT PERMITTED BY APPLICABLE LAW, IN NO EVENT AND UNDER NO LEGAL THEORY SHALL HME OR ITS SUPPLIERS BE LIABLE TO YOU FOR ANY COSTS OF SUBSTITUTE PRODUCTS, OR FOR ANY CONSEQUENTIAL, SPECIAL, INCIDENTAL, PUNITIVE OR INDIRECT DAMAGES OF ANY KIND ARISING OUT OF THE LICENSE OF, USE OF, OR INABILITY TO USE ANY HME SOFTWARE OR DOCUMENTATION, EVEN IF HME HAS BEEN ADVISED OF THE POSSIBILITY OF SUCH DAMAGES. IN NO EVENT SHALL HME'S OR ITS SUPPLIERS' LIABILITY EXCEED THE LICENSE FEE PAID BY YOU. THIS LIMITATION OF LIABILITY AND RISKS IS REFLECTED IN THE PRICE OF THE SOFTWARE LICENSE.

- 10) **AUDIT.** During the term of this Agreement and for three (3) years after termination or expiration, you will maintain complete records regarding your use and distribution of the Software. Upon reasonable notice to you, HME may audit, at HME's expense, your books and records to determine your compliance hereunder. In the event any such audit reveals that you have underpaid HME by an amount greater than five percent (5%) of the amounts due HME in the period being audited, or that you have knowingly breached any material obligation hereunder, then, in addition to such other remedies as HME may have, you shall pay or reimburse to HME the cost of the audit.

**11) U.S. GOVERNMENT RESTRICTED RIGHTS.** The Software and accompanying documentation are deemed to be "commercial computer software" and "commercial computer software documentation," respectively, pursuant to DFAR Section 227.7202 and FAR Section 12.212, as applicable. Any use, modification, reproduction, release, performance, display or disclosure of the software and accompanying documentation by the U.S. Government shall be governed solely by the terms of this Agreement and shall be prohibited except to the extent expressly permitted by the terms of this Agreement.

You must affix the following legend to each copy of the Software:

Use, duplication, reproduction, or transfer of this commercial Software and accompanying documentation is restricted in accordance with FAR 12.212 and DFARS 227.7202 and by a license agreement.  
Contact HM Electronics, Inc., 14110 Stowe Drive, Poway, California, 92064 U.S.A.

**HME DISCLAIMS ANY REPRESENTATION OR WARRANTY MADE BY ANY DISTRIBUTOR, RESELLER OR DEALER TO YOU WHETHER EXPRESS OR IMPLIED.**

Should you have any questions concerning this AGREEMENT, or if you desire to contact HME for any reason, please contact us: HM Electronics, Inc., 14110 Stowe Drive, Poway, California, 92064, U.S.A.

## LIMITED WARRANTY

HM Electronics, Inc. (“HME”) warrants the **PRO850** for a period of three (3) years\* from the date of purchase against defects in materials or workmanship provided it was purchased from an authorized dealer. During the warranty period, defective HME Products will be repaired without charge for parts and labor. Simply return the defective HME Product with your sales slip as proof of the date of purchase. If a defective HME Product is returned prepaid to HME or an authorized HME service center, it will be repaired and returned prepaid. Replacement of nonconforming goods and repair of defective HME Products are the sole and exclusive remedies available under this warranty.

This warranty shall be void if (a) the HME Products have been tampered with, neglected, modified, abused or misused; (b) anyone other than HME employees or authorized HME service representatives provide service on or to the HME Products; or (c) the serial numbers are not intact.

THIS WARRANTY COVERS HME PRODUCTS, AND IS NOT EXTENDED TO ASSOCIATED NON-HME PRODUCTS OR ACCESSORIES, OR ANY DAMAGE TO HME PRODUCTS CAUSED BY SUCH NON-HME PRODUCTS OR ACCESSORIES. IN NO EVENT WILL HME BE LIABLE FOR INCIDENTAL OR CONSEQUENTIAL DAMAGES, OR LOSS OF PROFITS ARISING FROM THE USE OF OR INABILITY TO USE ANY HME PRODUCTS, OR FROM ACCIDENTS OR ACTS OF GOD.

HME MAKES NO WARRANTIES, EXPRESS OR IMPLIED, INCLUDING WARRANTIES OF MERCHANTABILITY AND FITNESS FOR A PARTICULAR PURPOSE, WITH RESPECT TO HME PRODUCTS EXCEPT AS SPECIFICALLY SET FORTH ABOVE.

This warranty is provided to the original purchaser of the HME Products described on this packing list and is non-transferable without the written permission of HME.

### **RETURN POLICY:**

ALL SALES FINAL. No returns will be accepted (except for nonconforming goods as specified above) unless HME authorizes such return and unless such return occurs within 90 days of receipt. A 15% restocking charge will be assessed on all such authorized returns. Authorized returns must be freight prepaid and shall include an authorization number noted on the outside of the package. Such authorization number will be provided by HME at the time it authorizes such return. All freight sent collect and packages without an authorization number will be refused and returned to sender.

- Exceptions: The 12VDC Power Supply is warranted for two years. The BAT40 Batteries and the HS14, HS20-3 Headsets are warranted for one year. The HS4-3 Earpiece is warranted for 90 days.

# IMPORTANT!

---

## **Waste Electrical and Electronic Equipment (WEEE)**

The European Union (EU) WEEE Directive (2002/96/EC) places an obligation on producers (manufacturers, distributors and/or retailers) to take-back electronic products at the end of their useful life. The WEEE Directive covers most HME products being sold into the EU as of August 13, 2005. Manufacturers, distributors and retailers are obliged to finance the costs of recovery from municipal collection points, reuse, and recycling of specified percentages per the WEEE requirements.

## **Instructions for Disposal of WEEE by Users in the European Union**

The symbol shown below is on the product or on its packaging which indicates that this product was put on the market after August 13, 2005 and must not be disposed of with other waste. Instead, it is the user's responsibility to dispose of the user's waste equipment by handing it over to a designated collection point for the recycling of WEEE. The separate collection and recycling of waste equipment at the time of disposal will help to conserve natural resources and ensure that it is recycled in a manner that protects human health and the environment. For more information about where you can drop off your waste equipment for recycling, please contact your local authority, your household waste disposal service or the seller from whom you purchased the product.

